

SIEMENS

SIMATIC HMI

HMI devices Comfort Panels

Operating Instructions

Preface

Overview	1
Safety instructions	2
Mounting and connecting the HMI device	3
Commissioning the device	4
Commissioning a project	5
Operating a project	6
Maintenance and care	7
Technical specifications	8
Technical Support	A
Abbreviations	B

Legal information

Warning notice system

This manual contains notices you have to observe in order to ensure your personal safety, as well as to prevent damage to property. The notices referring to your personal safety are highlighted in the manual by a safety alert symbol, notices referring only to property damage have no safety alert symbol. These notices shown below are graded according to the degree of danger.

⚠ DANGER
indicates that death or severe personal injury will result if proper precautions are not taken.
⚠ WARNING
indicates that death or severe personal injury may result if proper precautions are not taken.
⚠ CAUTION
with a safety alert symbol, indicates that minor personal injury can result if proper precautions are not taken.
CAUTION
without a safety alert symbol, indicates that property damage can result if proper precautions are not taken.
NOTICE
indicates that an unintended result or situation can occur if the relevant information is not taken into account.

If more than one degree of danger is present, the warning notice representing the highest degree of danger will be used. A notice warning of injury to persons with a safety alert symbol may also include a warning relating to property damage.

Qualified Personnel

The product/system described in this documentation may be operated only by **personnel qualified** for the specific task in accordance with the relevant documentation, in particular its warning notices and safety instructions. Qualified personnel are those who, based on their training and experience, are capable of identifying risks and avoiding potential hazards when working with these products/systems.

Proper use of Siemens products

Note the following:

⚠ WARNING
Siemens products may only be used for the applications described in the catalog and in the relevant technical documentation. If products and components from other manufacturers are used, these must be recommended or approved by Siemens. Proper transport, storage, installation, assembly, commissioning, operation and maintenance are required to ensure that the products operate safely and without any problems. The permissible ambient conditions must be complied with. The information in the relevant documentation must be observed.

Trademarks

All names identified by ® are registered trademarks of Siemens AG. The remaining trademarks in this publication may be trademarks whose use by third parties for their own purposes could violate the rights of the owner.

Disclaimer of Liability

We have reviewed the contents of this publication to ensure consistency with the hardware and software described. Since variance cannot be precluded entirely, we cannot guarantee full consistency. However, the information in this publication is reviewed regularly and any necessary corrections are included in subsequent editions.

Preface

Purpose of the operating instructions

These operating instructions contain information based on the requirements defined by DIN EN 62079 for mechanical engineering documentation. This information relates to the place of use, transport, storage, mounting, use and maintenance.

These operating instructions are intended for:

- Users
- Commissioning engineers
- Maintenance personnel

Read especially the information in the chapter "Safety instructions" (Page 25).

You can find more information such as operating instructions, examples and reference information in the online help of WinCC.

Basic knowledge required

General knowledge of automation technology and process communication is needed to understand the operating instructions. Knowledge of personal computers and the Microsoft operating systems is required to understand this manual.

Scope of the operating instructions

The operating instructions apply to the following HMI devices in conjunction with the WinCC software package:

- KP400 Comfort (4" Key Panel)
- KTP400 Comfort (4" Key&Touch Panel)
- KP700 Comfort (7" Key Panel)
- TP700 Comfort (7" Touch Panel)
- KP900 Comfort (9" Key Panel)
- TP900 Comfort (9" Touch Panel)
- KP1200 Comfort (12" Key Panel)
- TP1200 Comfort (12" Touch Panel)
- KP1500 Comfort (15" key panel)
- TP1500 Comfort (15" touch panel)
- TP1900 Comfort (19" touch panel)
- TP2200 Comfort (22" touch panel)

CAUTION

Manual belongs to HMI device

The supplied manual belongs to the HMI device and is also required to repeat commissioning. Keep all supplied and supplementary documentation for the entire service life of the HMI device.

Provide all stored documents to subsequent owners of the HMI device.

Trademarks

The following designations marked with the symbol ® are registered trademarks of Siemens AG:

- HMI®
- SIMATIC®
- WinCC®

Style conventions

Style Convention	Scope
"Add screen"	<ul style="list-style-type: none">• Terminology that appears in the user interface, for example, dialog names, tabs, buttons, menu commands• Required input, for example, limits, tag values.• Path information
"File > Edit"	Operational sequences, for example, menu commands, shortcut menu commands.
<F1>, <Alt+P>	Keyboard operation

Please observe notes labeled as follows:

Note

A note contains important information about the product described in the manual and its use, or a specific section of the manual to which you should pay particular attention.

Naming conventions

Term	Applies to	
Plant	<ul style="list-style-type: none"> • System • Machining center • One or more machines 	
Comfort HMI device HMI device Device	<ul style="list-style-type: none"> • KP400 Comfort • KTP400 Comfort • KP700 Comfort • TP700 Comfort • KP900 Comfort • TP900 Comfort • KP1200 Comfort • TP1200 Comfort 	<ul style="list-style-type: none"> • KP1500 Comfort • TP1500 Comfort • TP1900 Comfort • TP2200 Comfort
Key model Key HMI device	<ul style="list-style-type: none"> • KP400 Comfort • KP700 Comfort • KP900 Comfort • KP1200 Comfort 	<ul style="list-style-type: none"> • KP1500 Comfort
Touch model Touch HMI device	<ul style="list-style-type: none"> • KTP400 Comfort • TP700 Comfort • TP900 Comfort • TP1200 Comfort 	<ul style="list-style-type: none"> • TP1500 Comfort • TP1900 Comfort • TP2200 Comfort
WinCC	WinCC V11 (TIA Portal) or higher for configuring the devices up to and including the 12" device	WinCC V11 SP2 HSP Comfort (TIA Portal) or higher for configuring 15" and larger devices

Figures

This manual contains illustrations of the described devices. The illustrations can deviate from the particularities of the delivered device.

Table of contents

	Preface	3
1	Overview.....	13
1.1	Product description	13
1.2	Product package	15
1.3	Configuration of the devices	16
1.3.1	KP400 Comfort and KTP400 Comfort	16
1.3.2	KP700 Comfort to KP1500 Comfort, TP700 Comfort to TP2200 Comfort	18
1.3.3	Ports.....	19
1.4	Accessories.....	21
1.5	The HMI device in the operating process	22
1.6	Software options	23
2	Safety instructions	25
2.1	General safety instructions	25
2.2	Security information	26
2.3	Notes about usage.....	27
3	Mounting and connecting the HMI device	29
3.1	Preparation for mounting	29
3.1.1	Checking the package contents.....	29
3.1.2	Checking the operating conditions.....	30
3.1.3	Selecting a mounting position.....	30
3.1.4	Checking clearances.....	32
3.1.5	Preparing the mounting cutout.....	33
3.1.6	Labeling the function keys	34
3.2	Mounting the device.....	37
3.3	Connecting the device	41
3.3.1	Notes on connection	41
3.3.2	Connecting the equipotential bonding circuit.....	42
3.3.3	Connecting the power supply.....	44
3.3.4	Connecting the configuration PC	46
3.3.5	Connecting the PLC.....	48
3.3.6	Connecting a USB device	49
3.3.7	Connecting a printer.....	50
3.3.8	Connecting an audio device.....	51
3.3.9	Switching on and testing the HMI device.....	52
3.3.10	Securing the cables	53

4	Commissioning the device	55
4.1	Overview	55
4.1.1	Backup design.....	55
4.1.2	Changing memory cards.....	58
4.1.3	Front operator controls.....	60
4.2	Using the service concept.....	62
4.2.1	Enabling the service concept	62
4.2.2	Replacing HMI device	63
4.2.3	Disabling the service concept	64
4.3	Operating the device	65
4.3.1	Loader	65
4.3.2	Control Panel	67
4.3.3	Installed programs.....	68
4.3.4	Reference for system keys.....	69
4.3.5	Entering values with system keys	73
4.3.6	Using the screen keyboard	75
4.4	Configuring the device	79
4.4.1	Reference for functions	79
4.4.2	Changing settings for operation	80
4.4.2.1	Configuring the screen keyboard	80
4.4.2.2	Setting the character repeat.....	82
4.4.2.3	Setting the double-click.....	83
4.4.2.4	Calibrating the touch screen	83
4.4.3	Changing password protection	86
4.4.4	Changing HMI device settings	87
4.4.4.1	Setting the date and time	87
4.4.4.2	Changing regional settings.....	89
4.4.4.3	Backup registry information.....	90
4.4.4.4	Changing monitor settings	91
4.4.4.5	Setting the screen saver	94
4.4.4.6	Changing the printer properties	96
4.4.4.7	Enabling sound and setting sound volume	97
4.4.4.8	Assigning sound to an event.....	98
4.4.4.9	Restarting the HMI device.....	99
4.4.4.10	Displaying information about the HMI device.....	101
4.4.4.11	Displaying system properties	102
4.4.4.12	Displaying memory distribution	103
4.4.5	Setting storage location.....	104
4.4.6	Setting the delay time.....	105
4.4.7	Setting the uninterruptible power supply.....	106
4.4.8	State of uninterruptible power supply.....	108
4.4.9	Enabling PROFINET services.....	109
4.4.10	Synchronizing the time via the time server	111
4.4.11	Changing transfer settings	113
4.4.11.1	Configuring the data channel	113
4.4.11.2	Changing MPI/PROFIBUS DP settings	115

4.4.12	Configuring network operation	117
4.4.12.1	Overview of network operation	117
4.4.12.2	Setting the device name of the HMI device	118
4.4.12.3	Changing the network configuration	119
4.4.12.4	Changing the logon data	123
4.4.12.5	Changing e-mail settings	124
4.4.12.6	Configuring Telnet for remote control	125
4.4.13	Changing Internet settings	126
4.4.13.1	Changing general Internet settings	126
4.4.13.2	Setting the proxy server	127
4.4.13.3	Changing privacy settings	128
4.4.13.4	Importing and deleting certificates	130
4.4.14	Saving to external storage device (backup).....	131
4.4.15	Restoring from external storage device	133
4.4.16	Activate memory management	135
5	Commissioning a project	137
5.1	Overview	137
5.2	Operating modes	138
5.3	Using existing projects	138
5.4	Data transmission options.....	139
5.5	Transfer.....	140
5.5.1	Setting transfer mode.....	140
5.5.2	Start transfer	142
5.5.3	Testing a project	143
5.6	Backup and restore.....	144
5.6.1	Overview	144
5.6.2	Backing up and restoring data of the HMI device	145
5.7	Updating the operating system	146
5.7.1	Updating the operating system	146
5.7.2	Updating the operating system of the HMI device	147
5.8	Managing add-ons and license keys	149
5.8.1	Managing add-ons	149
5.8.2	Transferring license keys	150
5.8.3	Managing license keys.....	150

6	Operating a project	153
6.1	Overview	153
6.2	Function keys	156
6.3	Direct keys.....	156
6.4	Setting the project language	157
6.5	Input of values.....	158
6.6	Entering and editing numeric values.....	159
6.7	Entering or changing alphanumeric values.....	160
6.8	Displaying infotext.....	162
6.9	Closing the project	163
7	Maintenance and care	165
7.1	Maintaining and caring for the touch screen and keyboard overlay	165
7.2	Clean screen for Touch HMI devices.....	166
7.3	Spare parts and repairs.....	167
7.4	Recycling and disposal	167
8	Technical specifications	169
8.1	Certificates and approvals.....	169
8.2	Directives and declarations.....	172
8.2.1	Electromagnetic compatibility	172
8.2.2	ESD guideline	174
8.3	Dimension drawings.....	177
8.3.1	Dimension drawings of the FKP400 Comfort.....	177
8.3.2	Dimension drawings of the KP700 Comfort.....	178
8.3.3	Dimension drawings of the KP900 Comfort.....	179
8.3.4	Dimension drawings of the KP1200 Comfort.....	180
8.3.5	KP1500 Comfort dimension drawings.....	181
8.3.6	Dimension drawings of the KTP400 Comfort.....	182
8.3.7	Dimension drawings of the TP700 Comfort	183
8.3.8	Dimension drawings of the TP900 Comfort	184
8.3.9	Dimension drawings of the TP1200 Comfort	185
8.3.10	Dimension drawings of TP1500 Comfort	186
8.3.11	Dimension drawings of TP1900 Comfort	187
8.3.12	Dimension drawings of TP2200 Comfort	188
8.3.13	Dimensions for labeling strips	189

8.4	Technical specifications	191
8.4.1	KP400 Comfort to KP1200 Comfort, KTP400 Comfort to TP1200 Comfort	191
8.4.2	KP1500 Comfort, TP1500 Comfort to TP2200 Comfort	193
8.4.3	Ambient conditions.....	196
8.4.3.1	Transport and storage conditions	196
8.4.3.2	Operating conditions	197
8.4.3.3	Information on insulation tests, protection class and degree of protection.....	199
8.5	Bit assignment of the direct keys	200
8.5.1	KTP400 Comfort	200
8.5.2	KP400 Comfort.....	201
8.5.3	KP700 Comfort.....	201
8.5.4	TP700 Comfort.....	201
8.5.5	KP900 Comfort.....	202
8.5.6	TP900 Comfort.....	202
8.5.7	KP1200 Comfort	203
8.5.8	TP1200 Comfort.....	203
8.5.9	KP1500 Comfort	204
8.5.10	TP1500, TP1900 and TP2200 Comfort	204
8.6	Description of the ports	205
8.6.1	Power supply.....	205
8.6.2	PROFIBUS (Sub-D RS422/485).....	205
8.6.3	PROFINET (LAN) 10/100 Mb	206
8.6.4	PROFINET (LAN) 10/100/1000 Mb	206
8.6.5	USB.....	207
8.6.6	Audio (IN/OUT)	207
8.7	Communication with PLCs.....	208
8.8	Scope of functions with WinCC.....	209
A	Technical Support.....	213
A.1	Service and support	213
A.2	Troubleshooting	214
A.3	System events.....	214
B	Abbreviations.....	215
	Glossary	217
	Index.....	223

Overview

1.1 Product description

SIMATIC HMI Comfort Panels are a fully redesigned product line of the Touch Panels and Key Panels. The product line includes the following models:

- Five key panels (operated by keyboard) with 4", 7", 9", 12" and 15" displays
- Six touch panels (operated by touch screen) with 7", 9", 12", 15", 19" and 22" displays.
- One Key&Touch Panel (operated by keyboard and touch screen) with 4" display size



All devices offer the same excellent functionality and are configured exclusively with the innovative HMI software, WinCC. The software is integrated into the engineering framework, "Totally Integrated Automation Portal".

Features of the SIMATIC HMI Comfort Panels

Enclosure	Plastic enclosure for the 4" model Aluminum pressure enclosures for all 7" and larger models
Mounting format	Mounting and operation of the touch models in horizontal and vertical format The respective format must be selected during the configuration of the user interface.
Interfaces	2 PROFINET interfaces (exception: KP400 Comfort and KTP400 Comfort have only 1 PROFINET interface) Additional gigabit PROFINET interface for devices of 15" or more 1 PROFIBUS interface USB 2.0 ports: <ul style="list-style-type: none"> • USB host interface (type A) <ul style="list-style-type: none"> – 1 x for 4" model – 2 x for 7", 9" and 12" models • USB device interface (type Mini B) <ul style="list-style-type: none"> – 1 x for all models
Display	High-resolution TFT display in widescreen format with 16 million colors Wide viewing angle Completely dimmable
Operation	Text and numbers are entered with the key models using the keypad system familiar from cell phones Intuitive operating scheme of the key models based on the proven technique used for cell phone keypads All freely configurable function keys have LEDs. All keys have a clear pressure point for additional safety in the operation.
Software	Internet Explorer to display web pages Viewer for PDF, Excel and Word documents Runtime software with logging and scripting functionality, system diagnostics for SIMATIC controllers, display of trends (f(x), f(t)), etc.
Data storage	2 memory card slots <ul style="list-style-type: none"> • One slot for storing user data • One slot for using the service concept for simplified restart in the event of service. Project data and device settings are updated automatically on the system card. No data loss in case of power failure. Applies to the HMI device and inserted SIMATIC HMI memory cards ≥ 2 GB.
Controller	The system diagnostics of SIMATIC controllers can be read from the HMI device, which means no additional programming device is required.

1.2 Product package

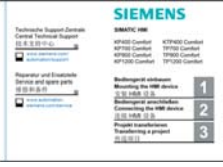
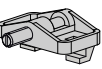
The following components are included in the product package of the HMI device.

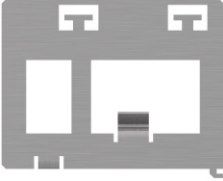
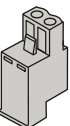
Name	Figure	Quantity
HMI device		1
Installation instructions (Quick Install Guide)		1
Mounting clamps with grub screw	 Plastic mounting clamps	6 KTP400 Comfort KP400 Comfort
	 Aluminum mounting clamps	12 TP700 Comfort KP700 Comfort
	 Steel mounting clamps	16 TP900 Comfort KP900 Comfort TP1200 Comfort KP1200 Comfort
Strain relief	Example: Strain relief KTP400/KP400 	12 TP1500 Comfort KP1500 Comfort TP1900 Comfort TP2200 Comfort
		1 KTP400 Comfort KP400 Comfort TP700 Comfort KP700 Comfort
Power supply terminal		1

1.3 Configuration of the devices

1.3.1 KP400 Comfort and KTP400 Comfort

The following sections describe the basic design of the KP400 Comfort and KTP400 Comfort HMI devices.

Front view

The following illustration shows the front view of the HMI devices, FKP400 Comfort (left) and KTP400 Comfort (right):

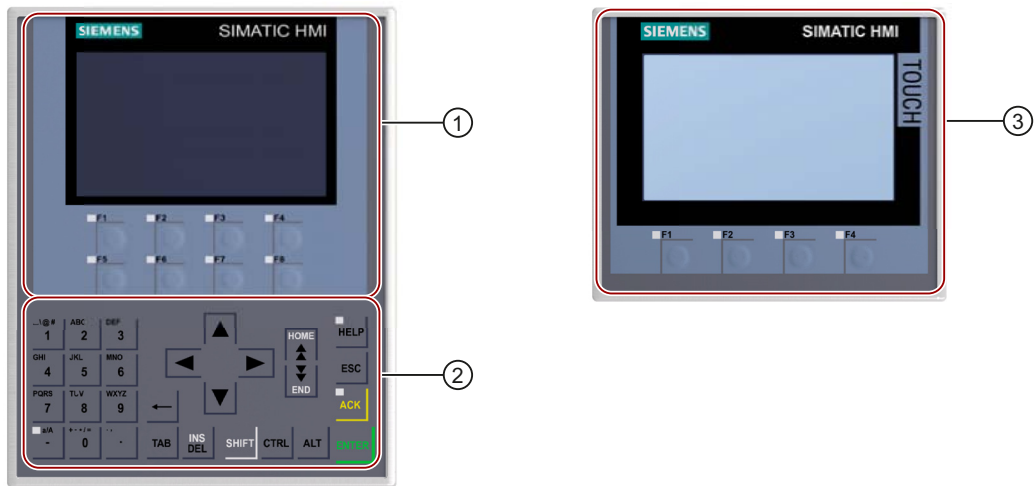

- ① Display with function keys
- ② Keyboard / system keys
- ③ Touch screen display with function keys

Rear view

The following illustration shows the rear view of the HMI devices, KP400 Comfort (left) and KTP400 Comfort (right):

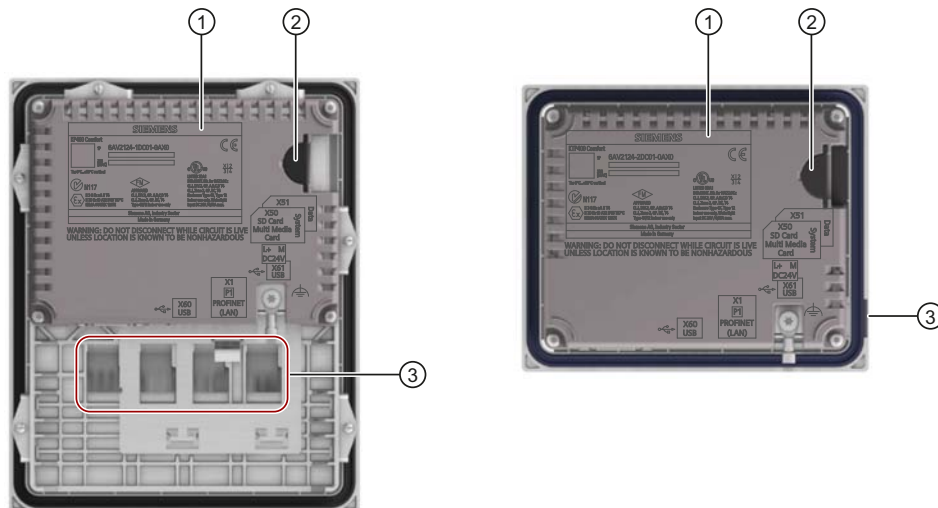

- ① Rating plate
- ② Slots for SD memory cards - accessible from the device side
- ③ Labeling strips

Side view

The following illustration shows the side views of the HMI devices, KP400 and KTP400 Comfort:

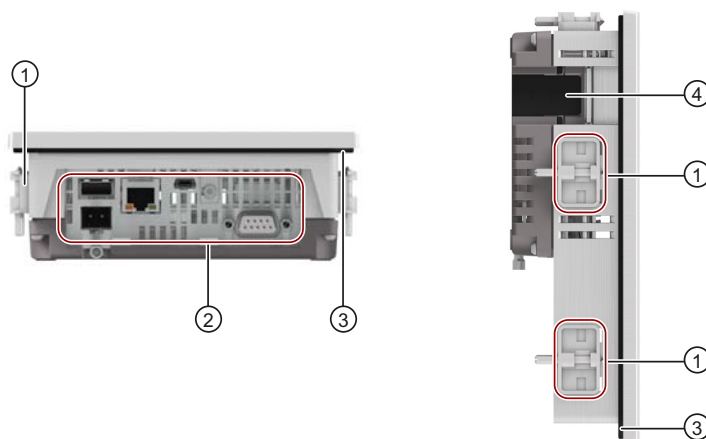

- ① Recesses for mounting clamps
- ② Interfaces
- ③ Mounting seal
- ④ Slots for SD memory cards

1.3.2 KP700 Comfort to KP1500 Comfort, TP700 Comfort to TP2200 Comfort

The following sections describe the basic design of the devices with 7" or larger displays, using the KP700 Comfort and TP700 Comfort as examples. The enclosure dimensions and form for the other models may differ from the illustrations shown.

Front view

The figure below shows the front view of the HMI devices, using the KP700 Comfort and TP700 Comfort as examples.

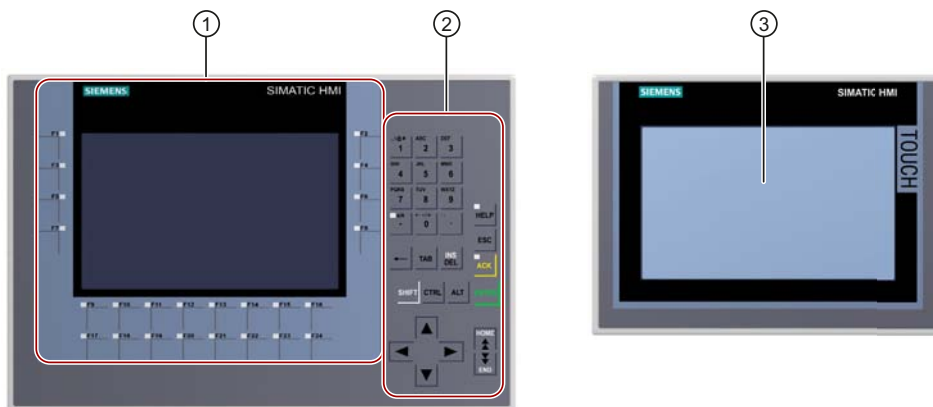

- ① Display with function keys
The number of function keys vary depending on display size
- ② Keyboard / system keys
- ③ Touch screen display

Rear view

The figure below shows the back view of the HMI devices, using the KP700 Comfort and TP700 Comfort as examples.

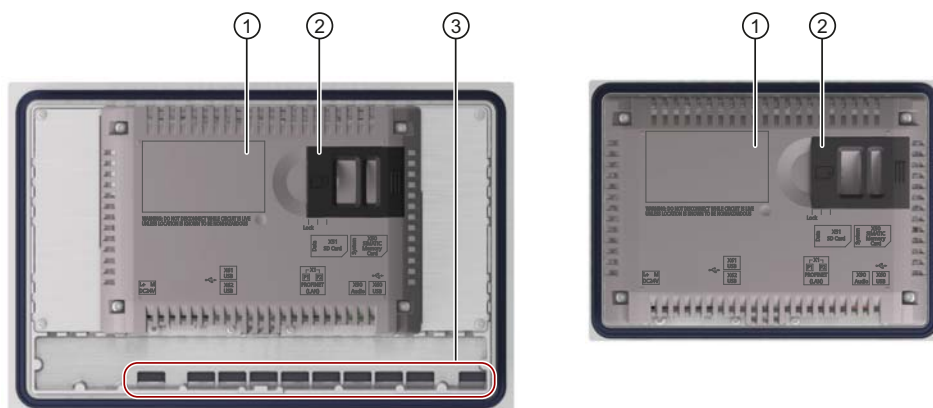

- ① Rating plate
- ② Slots for SD memory cards
- ③ Labeling strips

Side view

The figure below shows the side views of the HMI devices, using the KP700 Comfort and TP700 Comfort as examples.

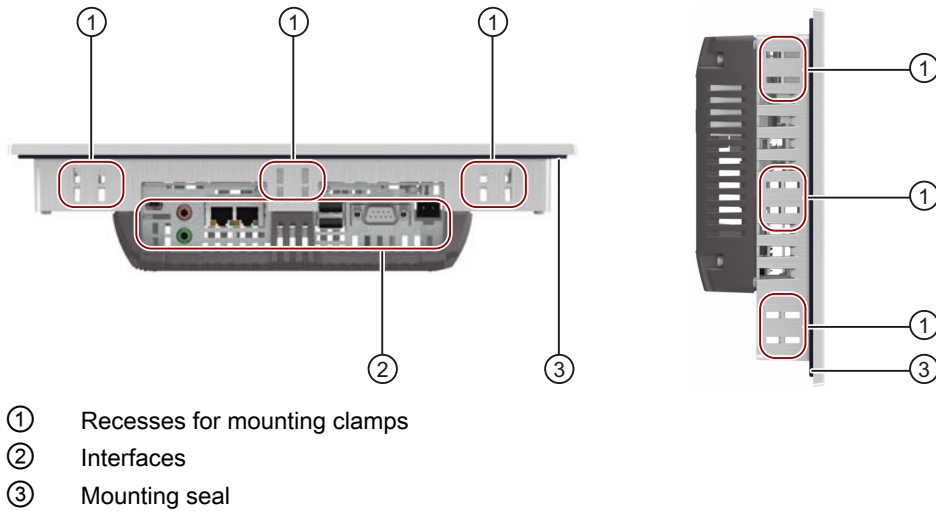

1.3.3 Ports

Interfaces for the 4" models

The figure below shows the KP400 and KTP400 Comfort interfaces.

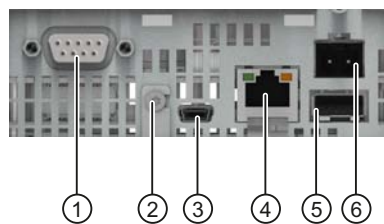

- | | |
|---|--------------------------------|
| ① X2 PROFIBUS (Sub-D RS422/485) | ④ X1 PROFINET (LAN), 10/100 Mb |
| ② Connection for equipotential bonding (ground) | ⑤ X61 USB type A |
| ③ X60 USB type Mini B | ⑥ X80 power supply connector |

Interfaces for the 7", 9" and 12" models

The figure below shows the interfaces for the following HMI devices:

- KP700 and TP700 Comfort
- KP900 and TP900 Comfort
- KP1200 and TP1200 Comfort

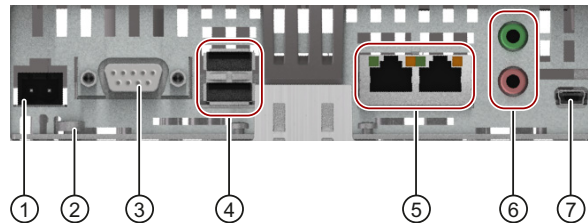

- | | |
|---|--------------------------------|
| ① X80 power supply connector | ⑤ X1 PROFINET (LAN), 10/100 Mb |
| ② Connection for equipotential bonding (ground) | ⑥ X90 Audio Line IN / OUT |
| ③ X2 PROFIBUS (Sub-D RS422/485) | ⑦ X60 USB type Mini B |
| ④ X61 / X62 USB type A | |

Interfaces for the 15", 19" and 22" models

The figure below shows the interfaces for the following HMI devices:

- KP1500 and TP1500 Comfort
- TP1900
- TP2200 Comfort

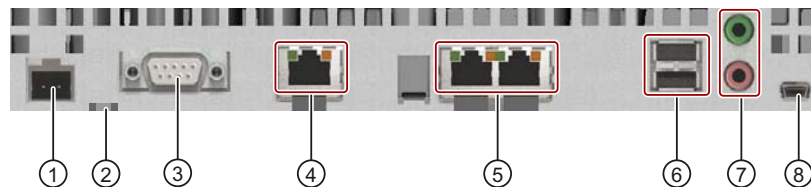

- | | |
|---|--------------------------------|
| ① X80 power supply connector | ⑤ X1 PROFINET (LAN), 10/100 Mb |
| ② Connection for equipotential bonding (ground) | ⑥ X61 / X62 USB type A |
| ③ X2 PROFIBUS (Sub-D RS422/485) | ⑦ X90 Audio Line IN / OUT |
| ④ X3 PROFINET (LAN), 10/100/1000 Mb | ⑧ X60 USB type Mini B |

Further information

Use the X1 or X60 interface to connect a configuration PC. Use the X61 / X62 interfaces to connect peripheral devices such as a printer or keyboard. Use the X90 interface to connect a loudspeaker.

You can affix the USB and PROFINET connecting cables to the rear panel of the HMI device with cable ties.

With the 4" and 7" models, protect the cables with a separate strain relief. Attach the strain relief to the HMI device.

See also

Description of the ports (Page 205)

1.4 Accessories

Accessories are not included in the product package of the HMI device, but can be ordered in the Internet at Industry Mall (<http://mall.automation.siemens.com>).

This section contains the number of accessories available at the time of publication of the operating instructions.

Converters and adapters

Name	Order no.
Converter RS 422 RS 232 for connecting third-party controllers	6AV6671-8XE00-0AX0
90° elbow adapter for RS422/RS485 interface	6AV6671-8XD00-0AX0

Protective foil

Name	Order no.
Protective foil set for KTP400 Comfort	6AV2124-6DJ00-0AX0
Protective foil set for TP700 Comfort	6AV2124-6GJ00-0AX0
Protective foil set for TP900 Comfort	6AV2124-6JJ00-0AX0
Protective foil set for TP1200 Comfort	6AV2124-6MJ00-0AX0
Protective films for TP1500 Comfort	6AV2124-6QJ00-0AX0
Protective films for TP1900 Comfort	6AV2124-6UJ00-0AX0
Protective films for TP2200 Comfort	6AV2124-6XJ00-0AX0

Memory media

Use only the following storage media for the HMI device.

Name	Order no.
2 GB SIMATIC HMI memory card	6AV2181-8XP00-0AX0
SIMATIC PC USB flash drive	6ES7648-0DC50-0AA0

Memory card lock protection

Name	Order no.
Memory card lock protection for 4" Comfort Panels	6AV2181-4DM10-0AX0
Memory card lock protection for 7" - 22" Comfort Panels	6AV2181-4XM00-0AX0

Service packages

Name	Order no.
Set with 20 plastic clamps for KP400 Comfort and KTP400 Comfort	6AV6671-8KX00-0AX2
Set with 20 aluminum mounting clamps for TP700 Comfort, KP700 Comfort, TP900 Comfort, KP900 Comfort, TP1200 Comfort and KP1200 Comfort	6AV6671-8XK00-0AX0
Set with 20 steel mounting clamps for KP1500 Comfort, TP1500 Comfort, TP1900 Comfort and TP2200 Comfort	6AV6671-8XK00-0AX3
Set of 10 power supply terminals	6AV6671-8XA00-0AX0

1.5 The HMI device in the operating process

The HMI device is part of the operating process. The following two phases are key to the way the HMI device is integrated in the process:

- Configuration
- Process management

Configuration

During the configuration phase, you create the user interfaces for operation and monitoring of the technical process to a configuring PC with WinCC as of version 11. Configuration also includes:

- Creating project data
- Saving project data
- Testing project data
- Simulating project data

After compiling the configuration, you load the project into the HMI device.

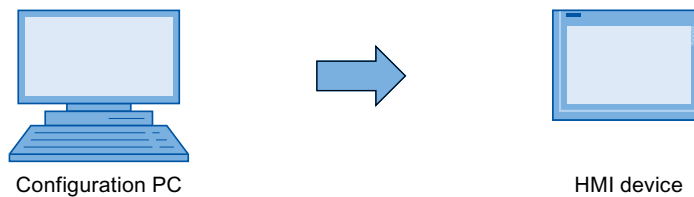

Process management

Process management is marked by two-way communication between HMI device and PLC.

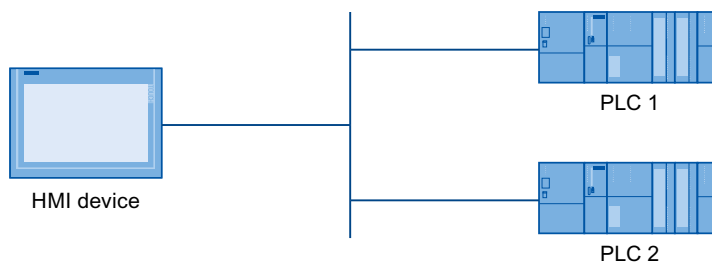

You then use the HMI device to operate and monitor the process.

1.6 Software options

The following software add-ons are available for the HMI devices:

Add-on	Description
WinCC /Sm@rtServer ¹	The WinCC /Sm@rtServer add-on enables you to access a remote HMI device from the HMI device or PC via Ethernet. It also enables you to set up communication between different HMI systems.
WinCC /Audit ¹	The WinCC /Audit add-on extends the HMI device to include functions for recording operations in an audit trail and electronic signature.
Uninterruptable Powersupply (UPS) with USB support ²	When interfacing an uninterruptible power supply, the HMI device is shut down in a controlled manner after a buffer time in the event of a power failure. The HMI devices support SITOP DC UPS modules connected via the USB port.
Microsoft Excel Viewer ³	Microsoft Excel Viewer enables you to display Excel documents.
Microsoft PDF Viewer ³	Microsoft PDF Viewer enables you to display PDF documents.
Microsoft Word Viewer ³	Microsoft Word Viewer enables you to display Word documents.
Printer driver	The printer driver option enables PostScript, HTML and PDF output for all HMI device print options.

¹ Transferred with the project; a license key is required for use

² Must be transferred as an option; no license key is required for use

³ Pre-installed; no license key is required for use

See also

Printers approved for SIMATIC Panels and Multi Panels

(<http://support.automation.siemens.com/WW/view/en/11376409>)

Printing with SIMATIC Comfort HMI devices

(<http://support.automation.siemens.com/WW/view/en/58205602>)

Safety instructions

2.1 General safety instructions

Open equipment and the Machinery Directive

 WARNING
<p>The device constitutes open equipment</p> <p>The device constitutes open equipment. This means that the device may only be installed in enclosures or cabinets which provide front access for operating the device.</p> <p>Access to the enclosure or cabinet in which the device is installed should only be possible by means of a key or tool and for trained and authorized personnel.</p> <p>Electrocution risk when control cabinet is open</p> <p>When you open the control cabinet, there may be a dangerous voltage at certain areas or components.</p> <p>Touching these areas or components can cause electrocution.</p> <p>Always disconnect the cabinet from the mains before opening it.</p> <p>The device may only be used in machines which comply with the Machinery Directive</p> <p>The Machinery Directive specifies precautions to be taken when commissioning and operating machinery within the European Economic Area.</p> <p>Failure to follow these precautions is a breach of the Machinery Directive. Such failure may also cause personal injury and damage depending on the machine operated.</p> <p>The machine in which the HMI device is to be operated must conform to Directive 2006/42/EC.</p>

Hazardous areas

When operating the HMI device in hazardous areas the following warning applies.

 WARNING
<p>Explosion Hazard</p> <p>Do not disconnect while circuit is live unless area is known to be non-hazardous. Substitution of components may impair suitability for Class I, Division 2 or Zone 2.</p>

High frequency radiation

CAUTION
Unwanted operating states
High-frequency radiation, for example from cellular phones, interferes with device functions and can cause device malfunction.
This causes injury and damages the plant.
Avoid high-frequency radiation:
<ul style="list-style-type: none">• Remove the sources of radiation from the vicinity of the device.• Switch off radiating devices.• Reduce the radio output of radiating devices.• Observe the information on electromagnetic compatibility.

2.2 Security information

Siemens offers IT security mechanisms for its portfolio of automation and drive products in order to support safe operation of the plant/machine. We recommend that you stay informed about the IT security developments for your products. For information on this topic, refer to: Industry Online Support (http://www.siemens.de/automation/csi_en_WW): You can register for a product-specific newsletter here.

For the safe operation of a plant/machine, however, it is also necessary to integrate the automation components into an overall IT security concept for the entire plant/machine, which corresponds to the state-of-the-art IT technology. You can find information on this under: Industrial Security (<http://www.siemens.com/industrialsecurity>).

Products used from other manufacturers should also be taken into account here.

2.3 Notes about usage

CAUTION
HMI device approved for indoor use only The HMI device may be damaged if operated outdoors. Operate the HMI device indoors only.

Industrial applications

The HMI device is designed for industrial applications. It conforms to the following standards:

- Requirements for emissions EN 61000-6-4: 2007
- Requirements for interference immunity EN 61000-6-2: 2005

Use in residential areas

NOTICE
HMI device not intended for use in residential area The HMI device is not intended for use in residential areas. Operation of an HMI device in residential areas can have a negative influence on radio or TV reception.

If the HMI device is used in a residential area, you must take measures to achieve Limit Class B conforming to EN 55011 for RF interference.

Suitable measures for achieving the degree of noise suppression for Limit Class B include, for example:

- Installation of the HMI device in grounded control cabinets
- Use of filters in electrical supply lines

Individual acceptance is required.

Mounting and connecting the HMI device

3.1 Preparation for mounting

Select the mounting location of the HMI device

Points to observe when selecting the mounting location:

- Position the HMI device so that it is not subjected to direct sunlight.
- Position the HMI device such that it is ergonomically accessible for the operator.

Choose a suitable mounting height.

- Ensure that the HMI device air vents are not covered as a result of installation.
- Note the permissible mounting positions.

3.1.1 Checking the package contents

Check the package content for visible signs of transport damage and for completeness.

NOTICE
Damaged parts A damaged part will cause the HMI device to malfunction. Do not install parts damaged during shipment. In the case of damaged parts, contact your Siemens representative.

Check the product package of the HMI device (see Product package (Page 15)).

Additional documents may be included in the delivery.

The documentation belongs to the HMI device and is required for subsequent commissioning. Retain all enclosed documentation for the entire service life of the HMI device. You must pass on the enclosed documentation to any subsequent owner or user of the HMI device. Make sure that every supplement to the documentation that you receive is stored together with the operating instructions.

3.1 Preparation for mounting

3.1.2 Checking the operating conditions

Note the following aspects before installing the HMI device:

1. Familiarize yourself with the standards, approvals, EMC parameters and technical specifications for operation of the HMI device. This information is available in the following sections:
 - Certificates and approvals (Page 169)
 - Electromagnetic compatibility (Page 172)
2. Check the mechanical and climatic ambient conditions for operation of the HMI device: Ambient conditions (Page 196).
3. Follow the instructions for local use of the HMI device: Notes about usage (Page 27).
4. Adhere to the permissible rated voltage and the associated tolerance range:
 - Rated voltage: +24 V DC
 - Tolerance range: 19.2 V to 28.8 V

3.1.3 Selecting a mounting position

The HMI device is suitable for installation in:

- Mounting cabinets
- Control cabinets
- Switchboards
- Consoles

In the following, all of these mounting options are referred to by the general term "cabinet".

The HMI device is self-ventilated and approved for inclined mounting at angles up to +/-35° in stationary cabinets.

CAUTION
Damage due to overheating
An inclined installation reduces the convection by the HMI device and therefore the maximum permissible ambient temperature for operation.
If there is sufficient forced ventilation, the HMI device can also be operating in the inclined mounting position up to the maximum permissible ambient temperature for vertical installation. The HMI device may otherwise be damaged and its certifications and warranty will be void.

For information regarding the permissible ambient temperatures, refer to Ambient conditions (Page 196).

Mounting position

Select one of the approved mounting positions for your HMI device. The approved mounting positions are described in the following sections.

Mounting in horizontal format

All HMI devices are suitable for horizontal mounting positions.

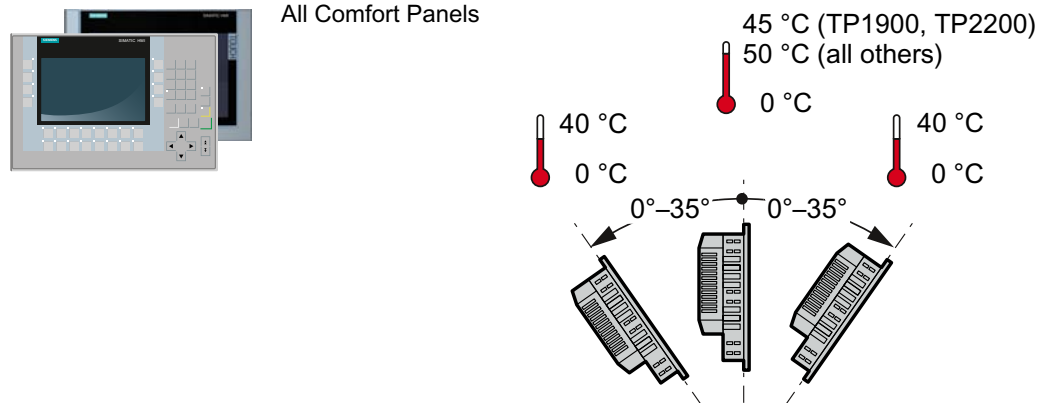

A maximum ambient temperature of +50 °C is permissible for vertical mounting (0° tilt angle); a maximum of +40 °C is permitted for inclined mounting.

The ambient temperature for TP1900 and TP2200 Comfort when installed vertically should not exceed +45 °C.

Mounting in vertical format

The Touch HMI devices are also suitable for mounting in vertical format. Select the appropriate screen format during configuration.

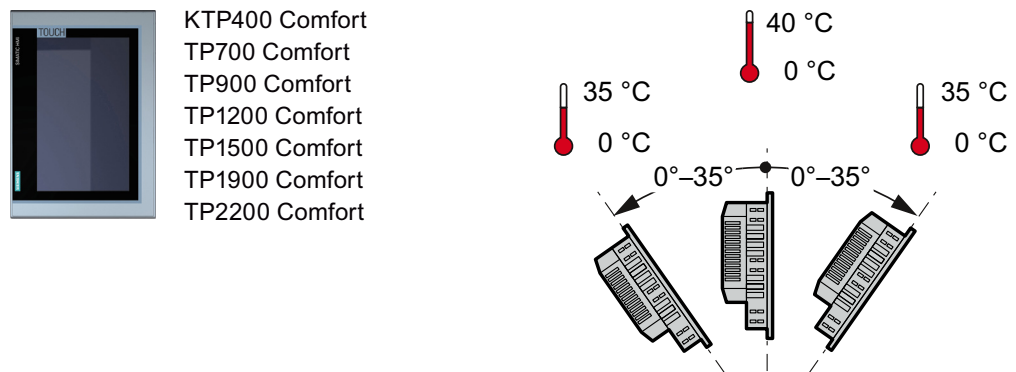

A maximum ambient temperature of +40 °C is permissible for vertical mounting (0° tilt angle); a maximum of +35 °C is permitted for inclined mounting.

3.1.4 Checking clearances

The following clearances are required around the HMI device to ensure sufficient self-ventilation:

- 15 mm to the right and 15 mm to the left of the mounting cutout (in the x direction) for inserting the mounting clamps during installation
- At least 50 mm above and 50 mm below the mounting cutout (in the y direction) for ventilation
- At least 10 mm behind the rear panel of the HMI device (in the z direction)

The following figure shows the clearances during the mounting of the HMI devices in horizontal and vertical formats:

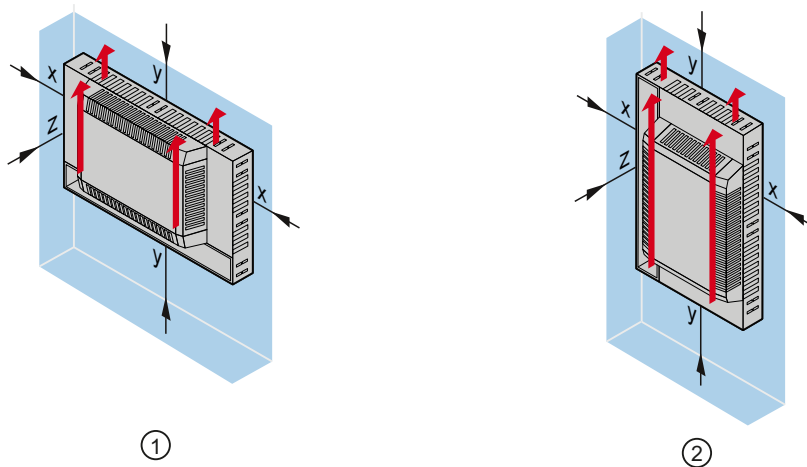

- ① Clearance for mounting in horizontal format (all HMI devices)
- ② Clearance for mounting in vertical format (Touch HMI devices only)
- x At least 15 mm distance
- y At least 50 mm distance
- z At least 10 mm distance

NOTICE

Ensure that the maximum ambient temperature is not exceeded when mounting the device in a cabinet and especially in a closed enclosure.

3.1.5 Preparing the mounting cutout

NOTICE
Stability of the mounting cutout
The material in the area of the mounting cutout must provide sufficient strength to guarantee the enduring and safe mounting of the HMI device.
The force of the clamps or operation of the device may not lead to deformation of the material in order to achieve the degrees of protection described below.

Degrees of protection

The degrees of protection of the HMI device can only be guaranteed if the following requirements are met:

- Material thickness at the mounting cutout for a protection rating of IP65 or Front face only Type 4X/Type 12 (indoor use only): 2 mm to 6 mm
- Permitted deviation from plane at the mounting cutout: ≤ 0.5 mm
This condition must be fulfilled for the mounted HMI device.
- Permissible surface roughness in the area of the seal: ≤ 120 μm (R_z 120)

Compatibility of the mounting cutout to other HMI devices

The mounting cutouts of the following HMI devices are compatible with the mounting cutouts of the following predecessor devices:

HMI device	Mounting cutout compatible to
KP400 Comfort	OP 77B
KTP400 Comfort	TP 177B 4"
KP700 Comfort	OP 277 6"
TP700 Comfort	TP 177B 6", MP 177 6", TP 277 6"
KP900 Comfort	MP 277 8" key
KP1500 Comfort	MP 377 12" key

Please note that although the dimensions for the mounting cut-out are the same, the device depth and/or the enclosure front dimensions may differ from the respective dimensions of the predecessor devices.

Dimensions of the mounting cutout

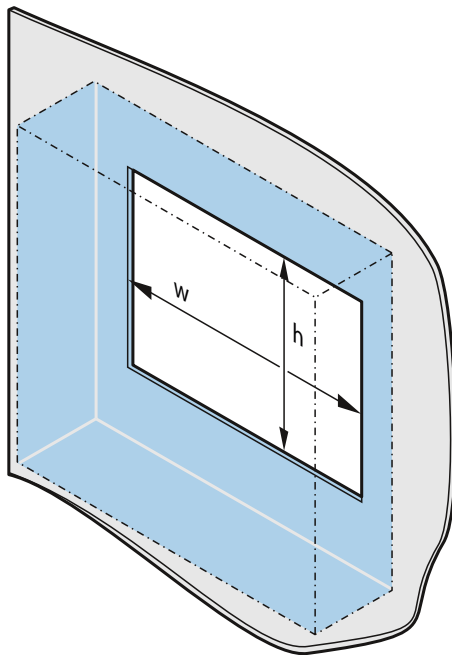

	w_{0}^{+1}	h_{0}^{+1}
KP400	135	171
KTP400	122	98
KP700	281	177
TP700	197	141
KP900	338	206
TP900	250	166
KP1200	434	268
TP1200	310	221
KP1500	450	291
TP1500	396	291
TP1900	465	319
TP2200	542	362

Width and height should be reversed accordingly when mounting in vertical format.

3.1.6 Labeling the function keys

Use the labeling strips to label the function keys of the HMI devices based on the project.

You will find labeling strip templates with a scale of 1:1 as a Word file:

- On the Internet at:
Downloads for Comfort Panels
(<http://support.automation.siemens.com/WW/view/en/47182890/133100>)
- In the "Support" folder on the WinCC installation DVD

If you want to make custom labeling strips, you can find the dimensions under "Dimensions for labeling strips (Page 189)".

Note

Do not write on the keyboard to label the function keys.

Any printable and writable foil can be used as labeling strip. The permitted thickness of the labeling strip is 0.15 mm. Paper labeling strips are inappropriate.

Procedure

Proceed as follows:

1. Edit the template on a PC and then print it.
2. Apply a fixing spray film to the labeling strips.

The printout can be made water and smudge-proof with a fixing spray. The color printer ink will not bleed onto the keyboard foil as well.

3. Cut out the labeling strip.
4. Ensure that the corners are cut at a 45° angle to it easier to slide them into the slot.
5. When the ink has dried, slide the labeling strips into the slot up to the end of the guide.

The image below shows the guides and labeling strips for the bottom two rows of keys on the KP1200 Comfort.

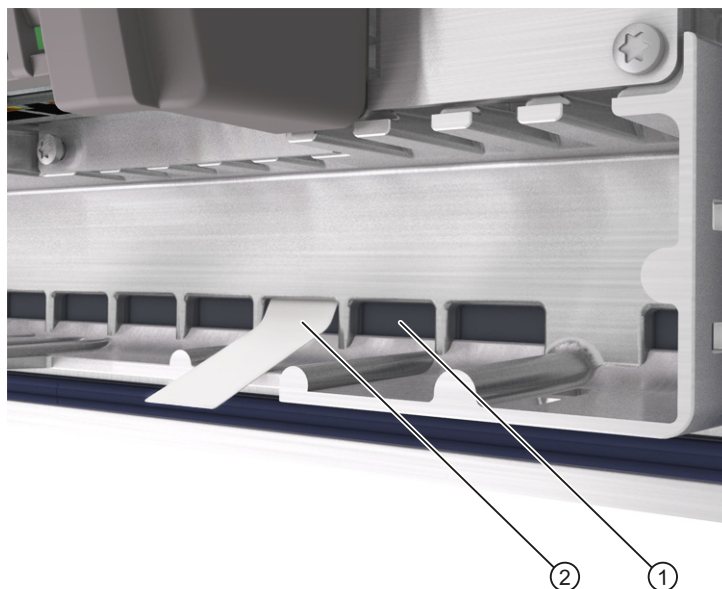

- ① Guide; the maximum number of guides depends on the HMI device used
- ② Labeling strips

3.1 Preparation for mounting

The image below shows the positions of the KP1500 Comfort guides and labeling strips.

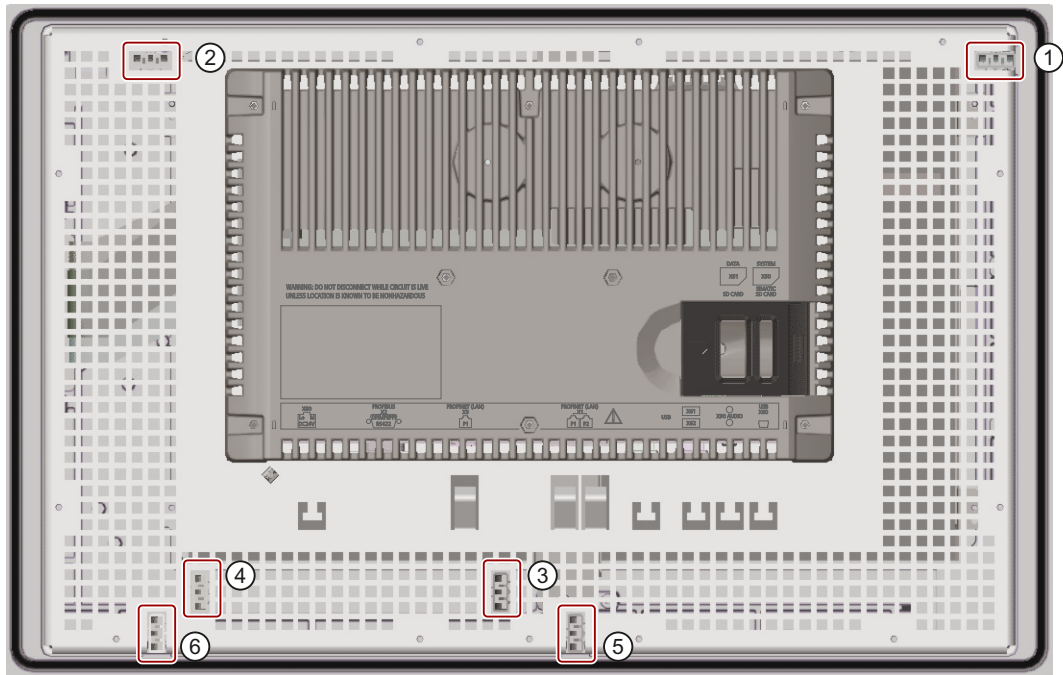

- ① Guide for labeling strips F1, F3 ... F15
- ② Guide for labeling strips F2, F4 ... F16
- ③ Guide for labeling strips F17 ... F22
- ④ Guide for labeling strips F23 ... F26
- ⑤ Guide for labeling strips F27 ... F31
- ⑥ Guide for labeling strips F32 ... F36

Result

The labeling strips protrude approximately 3 cm out of the slot. The template dimensions for the labeling strips are designed so that the labeling is correctly placed for the function keys. It is not necessary to secure the labeling strip.

When mounting the HMI device, ensure that the labeling strips do not get jammed between the mounting cut-out and the HMI device.

See also

Accessories (Page 21)



3.2 Mounting the device

Position of the mounting clamps

To ensure the necessary degree of protection on the HMI device, you need to use the mounting clamps with the positions listed below.

The positions of the mounting clamps are marked by stamps on the cutouts. Fit mounting clamps in all the stamped cutouts.

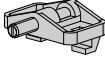
The following table shows the type, number and position of mounting clamps needed for the various HMI devices.

Comfort HMI device	Mounting clamps		
	Type	Quantity	Position on the HMI device
KTP400	Plastic mounting clamps 	4	 <p>KTP400 Comfort</p>
KP400		6	 <p>KP400 Comfort</p>

3.2 Mounting the device

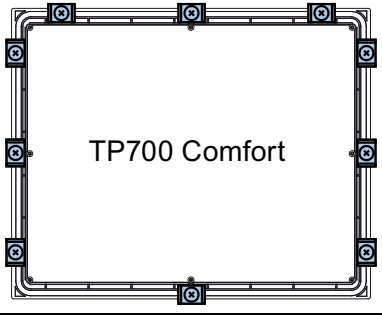
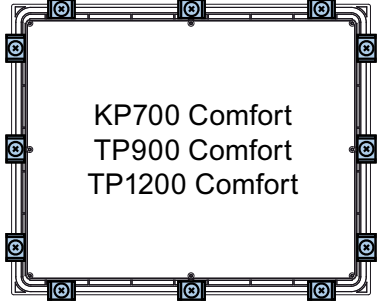
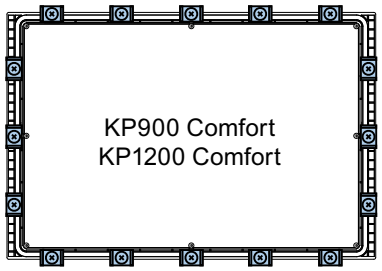
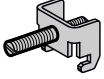
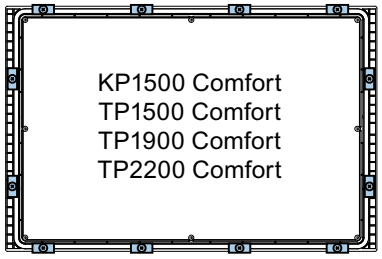
Comfort HMI device	Mounting clamps		
	Type	Quantity	Position on the HMI device
TP700	Aluminum mounting clamps 	10	 TP700 Comfort
KP700 TP900 TP1200		12	 KP700 Comfort TP900 Comfort TP1200 Comfort
KP900 KP1200		16	 KP900 Comfort KP1200 Comfort
KP1500 TP1500 TP1900 TP2200	Steel mounting clamps 	12	 KP1500 Comfort TP1500 Comfort TP1900 Comfort TP2200 Comfort

Requirement

- All packaging components and protective foils should be removed from the HMI device.
- To install the HMI device, you need the mounting clamps from the accessory kit.
- The mounting seal must be fitted on the HMI device.

Procedure

NOTICE
Risk of guaranteed degree of protection not being met If the mounting seal is damaged or protrudes beyond the HMI device, the degree of protection is not ensured. Checking the placement of the mounting seal To avoid leakage around the mounting cutout, do not install the mounting seal turned inside out. If the mounting seal is damaged, order a replacement seal.

NOTICE
Installation of the HMI device Always mount the HMI device according to the instructions in this manual.

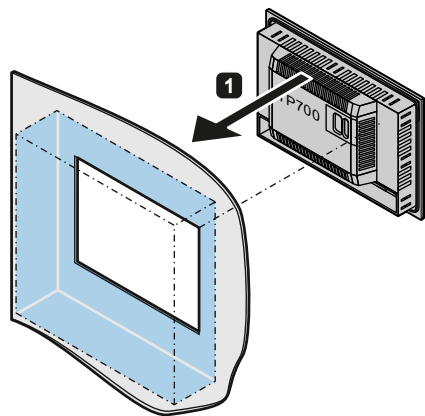

Mounting clamps for 4" models:

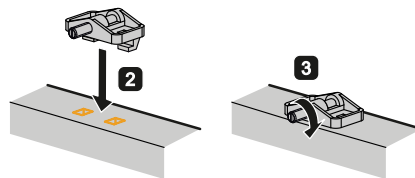

Mounting clamps for 7", 9", 12" models:

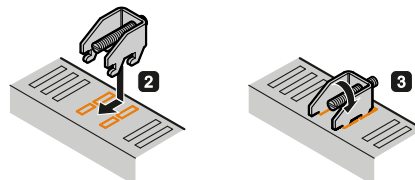

Mounting clamps for 15", 19" and 22" models:

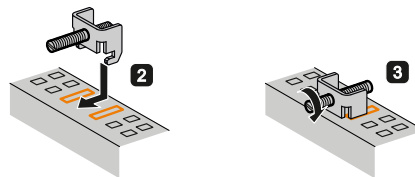

3.2 Mounting the device

Proceed as follows:

1. Insert the HMI device into the mounting cutout from the front.
2. Insert the mounting clamp into the cutout provided on the HMI device.
3. Tighten the mounting clamp with the threaded pin.

Note

Adhere to the permissible torque when tightening the threaded pin of the mounting clamp:

- 4" model: 0.2 Nm
 - 7" to 22" models: 0.5 Nm
-

4. Repeat steps 2 and 3 for all mounting clamps.
5. Check the fit of the mounting seal.

Result

The HMI device is mounted and the relevant degree of protection is ensured at the front.

See also

Accessories (Page 21)

3.3 Connecting the device

3.3.1 Notes on connection

Requirement

- The HMI device must be mounted according to the specifications of these operating instructions.
- Always use shielded standard cables for the data cable.

Additional information is available in the catalog and online order system at Industry Mall (<http://mall.automation.siemens.com>).

Connection sequence

Connect the HMI device in the following sequence:

1. Equipotential bonding
2. Power supply
Perform a power-up test to ensure the power supply is connected with the correct polarity.
3. PLC
4. Configuring PC as necessary
5. I/Os as necessary

NOTICE
Damage to the HMI device
If you do not keep to the connection sequence you could damage the HMI device. Ensure you connect the HMI device in the sequence stipulated above.

Disconnect the HMI device by completing the above steps in reverse order.

Connecting the cables

When connecting the cables, ensure that the contact pins are not bent. Secure the cable connectors by screwing the connector onto the socket. Provide adequate strain relief for the connecting cables.

3.3.2 Connecting the equipotential bonding circuit

Differences in electrical potential

Differences in electrical potential can develop between spatially separated plant components. Such electrical potential differences can lead to high equalizing currents over the data cables and therefore to the destruction of their interfaces. Equalizing currents can develop if the cable shielding is terminated at both ends and grounded to different plant parts.

Differences in potential may develop when a system is connected to different mains supplies.

General requirements for equipotential bonding

Differences in potential must be reduced by means of equipotential bonding in order to ensure trouble-free operation of the relevant components of the electronic system. The following must therefore be observed when installing the equipotential bonding circuit:

- The effectiveness of equipotential bonding increases as the impedance of the equipotential bonding conductor decreases or as its cross-section increases.
- If two plant parts are interconnected by means of shielded data cables and their shielding is bonded at both ends to the grounding/protective conductor, the impedance of the additionally installed equipotential bonding cable must not exceed 10% of the shielding impedance.
- The cross-section of an equipotential bonding conductor must be capable of handling the maximum equalizing current. Experience has shown that equipotential bonding conductors with a minimum cross-section of 16 mm² are the best.
- Use equipotential bonding conductors made of copper or galvanized steel. Establish a large surface contact between the equipotential bonding conductors and the grounding/protective conductor and protect these from corrosion.
- Use a suitable cable clip to clamp the shield of the data cable flush to the equipotential bonding rail. Keep the length of cable between the HMI device and the equipotential bonding rail as short as possible.
- Route the equipotential bonding conductor and data cables in parallel and with minimum clearance between these.

Wiring diagram

The figure below shows the equipotential bonding connection for the TP700 Comfort; it also applies to all other Comfort devices.

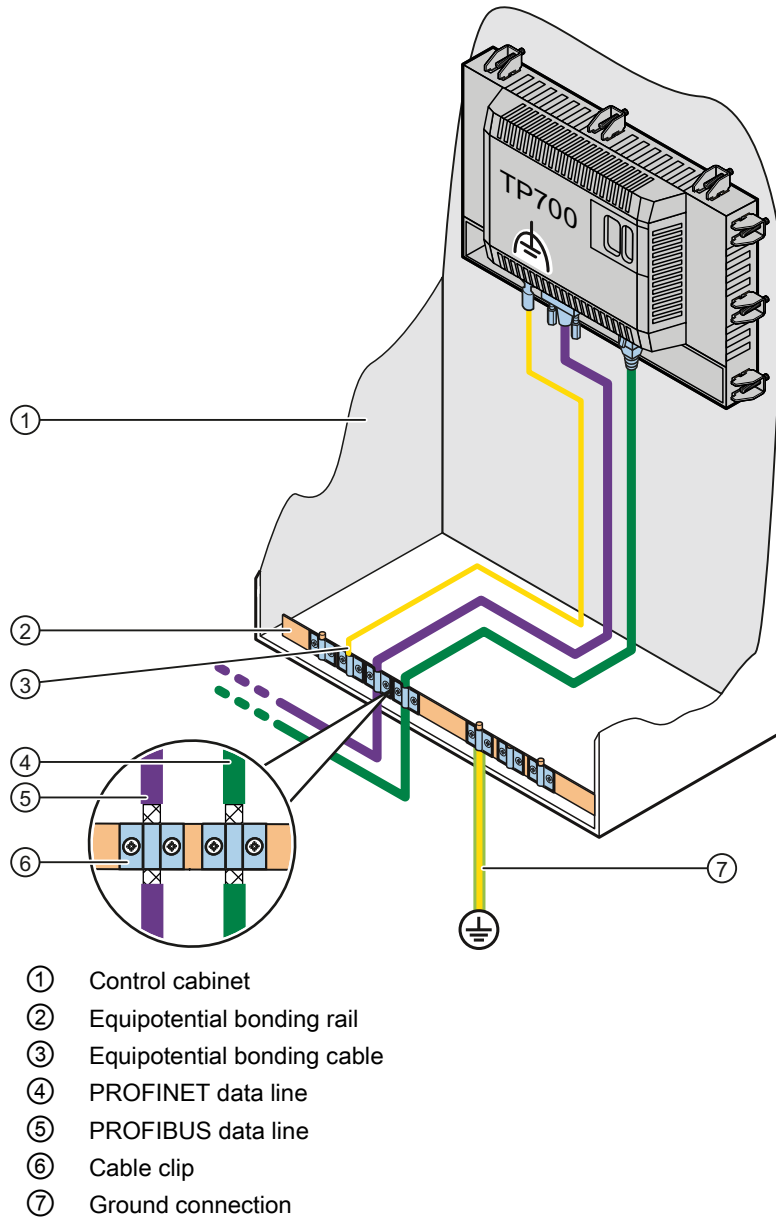

CAUTION

Damage to the interface modules possible

Cable shielding is not suitable for equipotential bonding.

Use only the prescribed equipotential bonding conductors. The minimum cross-section of a conductor used for equipotential bonding is 16 mm². The interface modules may otherwise be damaged or destroyed.

3.3.3 Connecting the power supply

CAUTION

Safe electrical separation

Use only 24 VDC power supply units with safe electrical isolation in accordance with IEC 60364-4-41 or HD 384.04.41 (VDE 0100, Part 410), e.g. to PELV standard.

The supply voltage must be within the specified voltage range. Otherwise, malfunction at the HMI device cannot be ruled out.

Applies to non-isolated plant configurations:

Connect the GND 24 V connection from the 24 V power supply output to equipotential bonding for uniform reference potential. You should always select a central point of termination.

Wiring diagram

The following figure shows the connection between the power supply and HMI device.

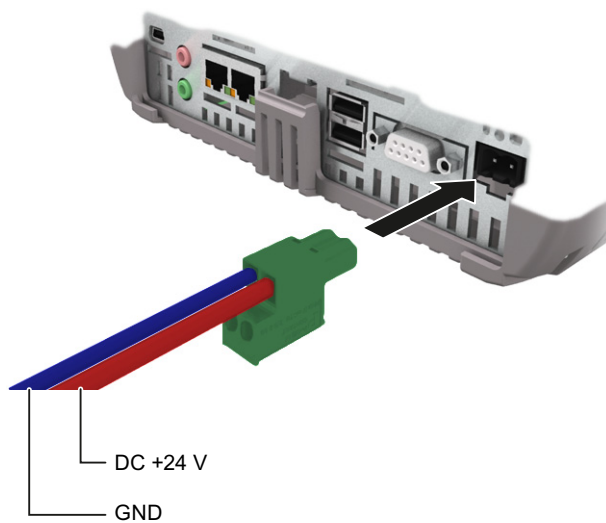

Note when connecting

The power supply terminal for connecting the power supply is contained in the accessory kit. The power supply terminal is designed for cables with a maximum cross-section of 1.5 mm².

Connecting the power supply terminal

NOTICE

Damage

Do not tighten the screws of the power supply terminal if it is plugged into the HMI device. The pressure from the screwdriver may otherwise damage the HMI device socket.

Only connect the wires when the power supply terminal is withdrawn.

Connect the power supply terminal to the cables of the power supply as shown in the figure above. Ensure that the lines are connected properly to the correct terminals. Refer to the label for the contact pins on the rear of the HMI device.

Reverse polarity protection

The HMI device is equipped with a reverse polarity protection circuit.

Connecting the uninterruptible power supply

The following figure shows the connection between the uninterruptible power supply (UPS) and HMI device. The uninterruptible power supply is connected to the 24-V input and one of the HMI device's USB type A ports.

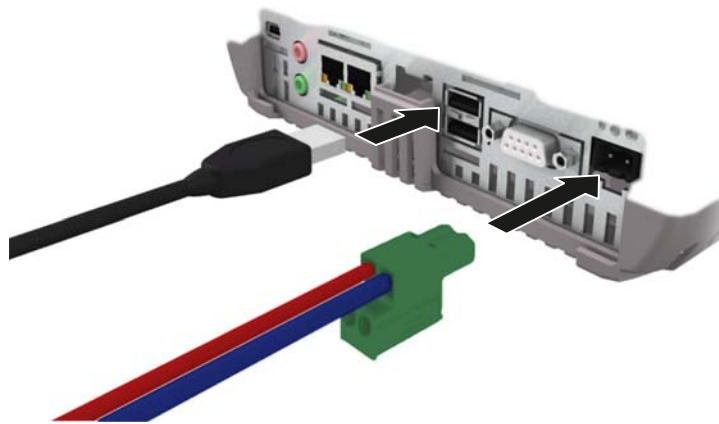

When connected to the HMI device's USB port, the following uninterruptible power supplies are supported:

SITOP DC UPS modules as of a rated power value of 6 A, e.g. 6EP1931-2DC42

See also

Setting the uninterruptible power supply (Page 106)

3.3.4 Connecting the configuration PC

Wiring diagram

The following figure shows how to connect the HMI device to a configuration PC.



- ① Connection to the configuration PC via PROFINET (LAN)
- ② Connection to the configuration PC via USB type Mini-B

The ports are described in the specifications.

Note

Alternatively, you can also connect the HMI device to the configuration PC via PROFIBUS. The transfer speed may result in extremely long transfer times.

Information on the USB type Mini B interface

NOTICE
USB type Mini B interface only suitable for commissioning
The USB type Mini B interface is not intended for connecting peripheral devices. The USB type Mini B interface may be used for commissioning and maintenance only.
USB 2.0 certified cable required
If you use a USB cable which is not USB 2.0 certified, errors may occur during data transfer.
Use only USB cables that are labeled "Certified HI-SPEED USB 2.0".
USB cable length maximum 1.5 m
USB cables with lengths more than 1.5 m do not ensure secure data transfer.
The cable length of the connected USB devices may not exceed 1.5 m.

Procedure

Proceed as follows:

1. Switch off the HMI device.
2. Switch on the configuration PC.
3. Connect the HMI device to the configuration PC either via the PROFINET (LAN) or via the USB type Mini-B interface. Please note the following for USB connection:
 - Connect the USB Mini B connector of the USB cable to the USB type Mini B interface of the HMI device.
 - Connect the USB A connector of the USB cable to a free USB interface of the configuration PC.
4. Switch on the HMI device.

Result

The configuration PC and HMI device are connected.

If you have connected the HMI device directly to the configuration PC via the PROFINET (LAN) interface, you will then need to assign an IP address to the HMI device.

If Windows XP is installed on the configuration PC and you have connected the HMI device to the configuration PC via USB, you will be prompted to install the USB driver. You can find the USB driver in the installation folder of WinCC.

Note

Updating the operating system

If there is no serviceable HMI device image on the HMI device, you can only update the operating system by restoring the factory setting. When restoring the factory settings, connect the PC to the HMI device via the PROFINET (LAN) interface.

Connecting multiple HMI devices in succession

If you connect more than one HMI device with the same IP address in succession to a single configuring PC, you need to ping the configuring PC once from the HMI device on each changeover of the HMI device.

3.3.5 Connecting the PLC

Wiring diagram

The figure below shows how to connect the HMI device to a PLC.



- ① Connection to the PLC via PROFINET (LAN)
- ② Connection to the PLC via PROFIBUS

NOTICE

Only use approved cables

If you do not use approved cables to connect a SIMATIC S7 controller, you may experience malfunctions.

Only use approved cables to connect a SIMATIC S7 controller.

Standard cables are available for the connection. You can find additional information on this in the Internet at Industry Mall (<http://mall.automation.siemens.com>).

Connecting PROFINET

NOTICE

PROFINET IO communication

For instructions regarding the installation of PROFINET networks, refer to the "PROFINET System Description" manual.

The following applies for devices with 7" or larger displays: The HMI device has an internal switch. This enables you to set up a ring topology, for example, with the HMI device without an external switch. Use the X1 interface to set up a ring topology for devices with a 15" or larger display.

See also

Communication with PLCs (Page 208)

3.3.6 Connecting a USB device

Below are examples of devices you can connect to the USB type A interfaces of the HMI device:

- External mouse
- External keyboard
- Printer
- USB memory stick
- Industrial USB Hub 4

Industrial USB hub 4 can be obtained using order number 6AV6671-3AH00-0AX0.

Note when connecting

<p>NOTICE</p> <p>USB type A interface not suitable for commissioning</p> <p>The USB type A interface is only intended for connecting peripheral devices. Do not use the USB type A interface for commissioning or maintenance.</p> <p>USB 2.0 certified cable required</p> <p>If you use a USB cable which is not USB 2.0 certified, errors may occur during data transfer. Use only USB cables that are labeled "Certified HI-SPEED USB 2.0".</p> <p>USB cable length maximum 1.5 m</p> <p>USB cables with lengths more than 1.5 m do not ensure secure data transfer. The cable may not be longer than 1.5 m.</p> <p>Functional problem with USB port</p> <p>If you connect an external device with a 230 V power supply to the USB port without using an non-insulated installation, you may experience functional problems. Use a non-insulated system design.</p> <p>Excessive rated load on port</p> <p>A USB device with too high a power load may possibly cause functional problems. Observe the values for the maximum load of the USB interface. You will find the values in the section "Technical specifications" (Page 207).</p>
--

3.3.7 Connecting a printer

Wiring diagram

The following figure shows the connection between the printer and HMI device.



Note when connecting

NOTICE
Data exchange cables
If you use cables without a metallic netting shield between the HMI device and printer, you may experience functional problems.
Only use cables with metal-braided shielding grounded at both ends for connecting the HMI device and printer.

Note

Some printers may require the ASCII character set used in the project to also be defined on the printer.

You can find the list of current printers and required settings for HMI devices in the Internet at Printers approved for SIMATIC Panels and Multi Panels (<http://support.automation.siemens.com/WW/view/en/11376409>).

Observe the supplied printer documentation when you connect the printer.

3.3.8 Connecting an audio device

You can use the following ports for audio devices:

- "Line Out", for example, for active speakers or external audio amplifier
- "Line In" for audio sources with line-in level

NOTICE

Cable to "Line Out" interface may cause increased emitted interference

If you connect an audio device to the "Line-Out" interface, the connection cable of the audio may cause increased emitted interference.

You should only use insufficiently shielded audio devices such as headsets and headphones on the "Line-Out" interface during commissioning.

If you use audio devices during productive operation, you need to ensure that the cables of these audio devices are shielded in such a manner that they comply with the applicable guidelines relating to emitted interference.

See also

Certificates and approvals (Page 169)

3.3.9 Switching on and testing the HMI device

Procedure

Proceed as follows:

1. Switching on the power supply.

The screen lights up after power is switched on. An animated graphic is displayed during startup.

If the HMI device fails to start, you have probably crossed the wires on the power supply terminal. Check the connected wires and change their connection. The Loader opens after the operating system has started.

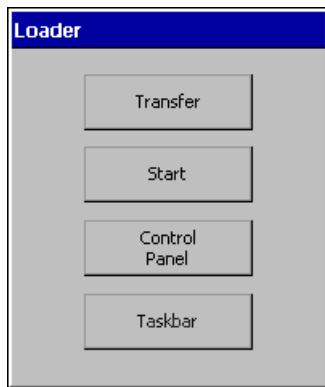

The HMI device automatically switches to "Transfer" mode during initial startup under the following conditions:

- No project is loaded on the HMI device.
- At least one data channel has been configured.

During this process the following dialog appears:

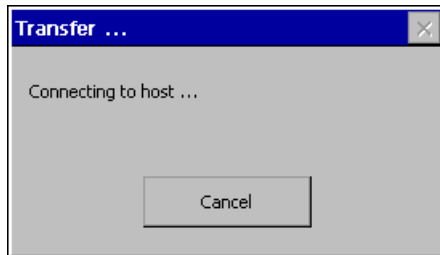

2. Press "Cancel" to stop the transfer.

Result

The Loader appears again.

Note

When restarting the system, a project may already be loaded on the HMI device. The project will then start after a configurable delay or when you press the "Start" button.

Use the relevant operating element to close the project.

Refer to your plant documentation to find any additional information on this topic.

Function test

Perform a function test following commissioning. The HMI device is fully functional when one of the following states is indicated:

- The "Transfer" dialog is displayed.
- The Loader is displayed.
- A project is started.

Shutting down the HMI Device

Terminate the project at the HMI device before switching it off.

You have the following options for switching off the HMI device:

- Switch off the power supply.
- Remove the power supply terminal from the HMI device.

See also

Configuring the data channel (Page 113)

3.3.10 Securing the cables

After the power-on test, to ensure strain relief, use cable ties to secure the connected cables to the marked fixing elements.



① Fasteners

Attaching a strain relief

With the 4" and 7" models, protect the cables with a separate strain relief. Attach the strain relief to the HMI device.

The following figure shows the fixing elements of the strain relief for the 4" model:

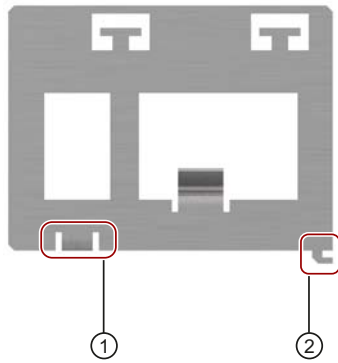

- ① Borehole for Torx screw
The strain relief is secured with the Torx screw of the connection for equipotential bonding. Before you attach the strain relief, unscrew the Torx screw.
- ② Safety nose

Proceed as follows:

1. Position the strain relief flush with the HMI device.
2. Push the strain relief to the right.
3. Secure the strain relief with the Torx screw.

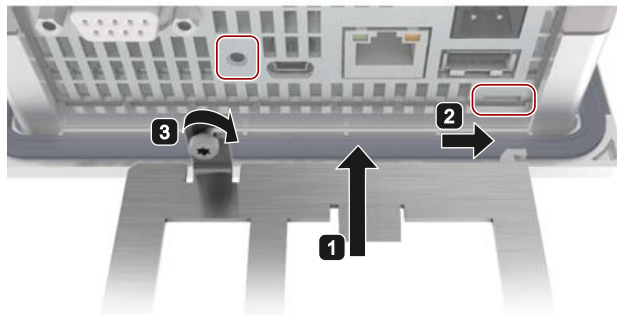

Commissioning the device

4.1 Overview

4.1.1 Backup design

Introduction

The HMI devices use the following memory types:

- Internal memory
- Memory card
- System memory card

You can also connect a USB mass storage device to the USB port.

Internal memory

The following data is saved in the internal memory:

- Operating system
- Project file
- License keys
- User administration
- Recipes^{*)}

^{*)} To save recipes in the internal memory, select "\\Flash\\" as the path in WinCC.

Note

Cyclic write access to the internal memory is not allowed

Cyclic write access to internal memory is not allowed, because this reduces the service life of internal memory and of the HMI device.

To prolong the service life of your device, you should preferably use external memory cards to store and log data, for example the SIMATIC HMI Memory Card.

Note

Number of allowed files in the root directory of the internal memory

The number of files in the root directory is limited to 256. The number of files is not limited in the subdirectories of the internal memory.

Memory card

The following data are saved on the memory card:

- Logs
- Backups
- Recipes*)

*) To save recipes on the memory card, select "\\StorageCard SD\" as the path in WinCC.

You can use commercially available memory cards with the "SD(IO / HC)" or "MMC" format. For data consistency reasons, Siemens recommends the use of the SIMATIC HMI Memory Card as the memory card, see Accessories (Page 21).

Note

Data consistency

When the HMI device is switched off, consistency of the stored data is ensured only for the SIMATIC HMI Memory Card ≥ 2 GB.

With commercially available memory cards, switching off the device may result in the loss of saved data, for example, due to a power failure.

The consistency of data stored in archives is only guaranteed if you use RDB format.

System memory card

The system memory map is part of the service concept of the HMI devices. If you enable the service concept, all data from the internal memory of the HMI device is transferred to the system memory card. If the HMI device fails, you insert the system's memory card into the replacement unit. This way you reduce your system downtimes to a minimum.

The system memory card is not visible in the user interface of the HMI device and it cannot be used for data storage. In order for the HMI device to recognize the system memory card, you have to insert the system memory card into the slot designed for it.

Note

Format of the system memory card

Only a SIMATIC HMI Memory Card ≥ 2 GB may be used as a system memory card. All other memory cards are not recognized as system memory card by the HMI device.

Slots for memory and system memory card

The slots for memory card and system memory card are on the back of the enclosure for the 7" models. The memory cards and system memory cards are thus accessible at the rear of the cabinet. The memory cards and system memory cards are protected by a safety lock. The memory cards and system memory cards can be hot-swapped during ongoing operation of the HMI device.

The slots are on the back of the enclosure for the 4" models.

The following figure shows the slots with safety lock:

KP400 Comfort
KTP400 Comfort

KP700 Comfort
KP900 Comfort
KP1200 Comfort
KP1500 Comfort

TP700 Comfort
TP900 Comfort
TP1200 Comfort
TP1500 Comfort
TP1900 Comfort
TP2200 Comfort

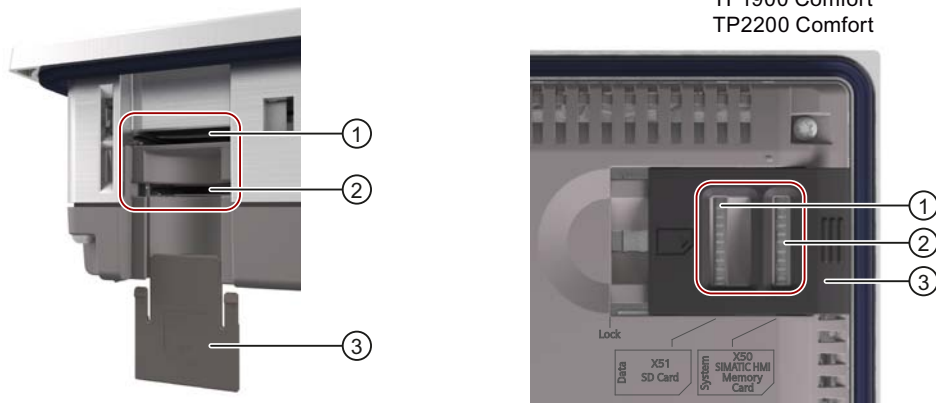

- ① Slot for memory card in the "SD(IO / HC)" or "MMC" format.
Recommendation: SIMATIC HMI memory card
- ② Slot for the system memory card.
Permissible: SIMATIC HMI Memory Card ≥ 2 GB
- ③ Safety lock
KP400 Comfort and KTP400 Comfort: infinitely variable
KP700 Comfort and TP700 Comfort and higher: two-level

4.1.2 Changing memory cards

Introduction

The memory cards and system memory cards are protected by a safety lock. The memory card and system memory card can be hot-swapped during ongoing operation of the HMI device.

NOTICE

Potential loss of data

The data on the memory card is lost if you attempt to remove it while the HMI device is accessing its data.

Do not remove the memory card while data is being accessed. Observe the corresponding alarms on the screen.

Removing the system memory card while the project is running

If you remove the system storage card while a project is running, the project is ended.

The following figure shows the slots with safety lock:

KP400 Comfort
KTP400 Comfort

KP700 Comfort TP700 Comfort
KP900 Comfort TP900 Comfort
KP1200 Comfort TP1200 Comfort
KP1500 Comfort TP1500 Comfort
TP1900 Comfort
TP2200 Comfort

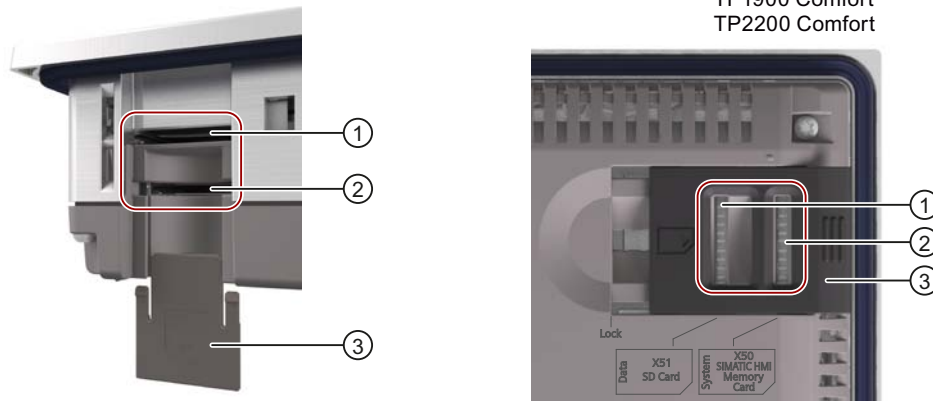

- ① Slot for memory card in the "SD(IO / HC)" or "MMC" format.
Recommendation: SIMATIC HMI memory card
- ② Slot for the system memory card.
Permissible: SIMATIC HMI Memory Card \geq 2 GB
- ③ Safety lock
KP400 Comfort and KTP400 Comfort: infinitely variable
KP700 Comfort and TP700 Comfort and higher: two-level

Requirement

Memory card and/or system memory card are read-only

Procedure

Note

Format of the system memory card

Only a SIMATIC HMI Memory Card ≥ 2 GB may be used as a system memory card. All other memory cards are not recognized as system memory card by the HMI device.

Proceed as follows:

1. Push the safety switch to the appropriate position.
2. To remove the memory card and/or system memory card, briefly press the card in question.

The card will be released and can be removed.

This step is not required during commissioning.

3. Insert the new memory card and/or system memory card.
4. Push the safety switch back to the initial position.

If you have inserted the system card, you are prompted by the HMI device to enable the service concept.

Result

Memory and/or system memory card are replaced.

See also

Enabling the service concept (Page 62)

Accessories (Page 21)

4.1.3 Front operator controls

Touch HMI device

You can operate the Touch HMI devices with the touch screen. All operating elements required for operation are displayed on the touch screen once the HMI device has started.

NOTICE
Unintentional action possible Do not carry out several operations simultaneously. You may otherwise trigger an unintentional action. Always touch only one operating element on the screen
Risk of damage to the touch screen Do not touch the touch screen with pointed or hard objects. Avoid applying excessive pressure to the touch screen with hard objects. Both these will substantially reduce the service life of the touch screen and can even lead to total failure. Only use your fingers to operate the HMI device touch screen. If required, use protective film for the touch screen, see Accessories (Page 21).

Key HMI devices

You operate the key HMI devices using the system keys and the function keys. The functions of the function keys are defined during configuration. The function keys have no function before the project is opened in the HMI device.

The following figure shows the front-sided operator controls of the key HMI devices using the KP700 Comfort as an example:

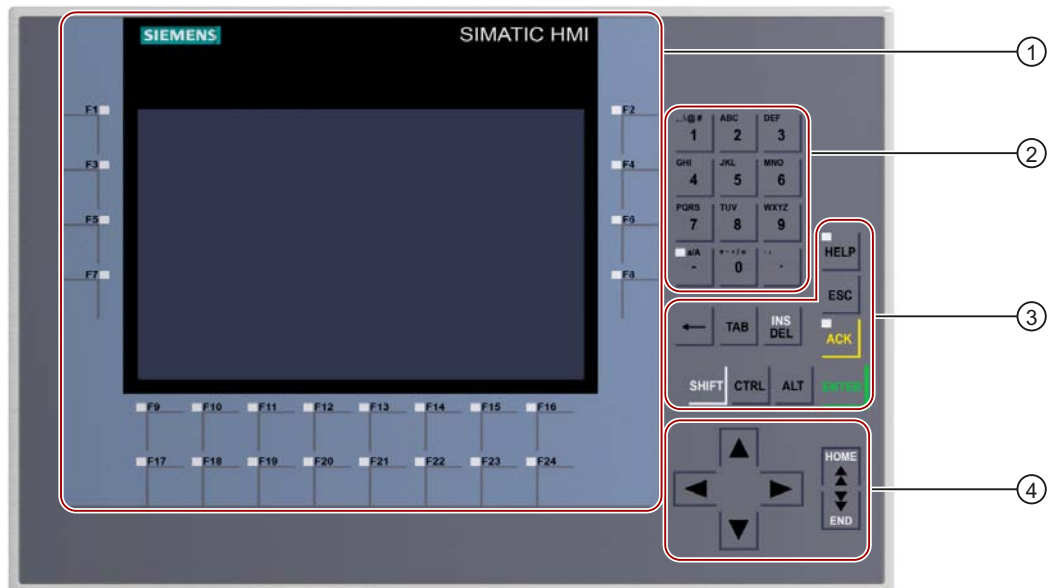

- ① Display and function keys with LED
The number of function keys vary depending on display size
- ② System keys - alphanumeric keys
- ③ System keys – control keys
- ④ System keys - cursor keys

NOTICE

Unintentional action possible

Do not carry out several operations simultaneously. You may otherwise trigger an unintentional action.

Do not press more than two keys simultaneously

Damage to the keyboard possible

Using hard instruments to press the keys considerably reduces the service life of the key mechanism.

Always use your fingers to operate the keys of your HMI device.

4.2 Using the service concept

If the service concept is enabled, the HMI device stores all data necessary for the operation on the system memory card. You can insert the system memory card into any HMI device of the same type. After copying the data and restarting the same-type HMI device is operational.

NOTICE

System memory card in a device of a different type

If you use the system memory card of an HMI device in an HMI device of a different type, an error message is displayed.

In the event of service, only use a system memory card in HMI devices of the same type.

4.2.1 Enabling the service concept

Requirement

- A new SIMATIC HMI Memory Card ≥ 2 GB is available.
- The slot for the system memory card is enabled (factory state).

If required, check the setting in the Control Panel under "OP Properties", "System Card" tab, see section "Disabling the service concept (Page 64)".

Procedure

To enable the service concept for commissioning on an HMI device, proceed as follows:

1. Switch on the power supply of the HMI device.
2. Move the safety lock into position 2.
3. Insert the memory card into the slot provided for it.
4. Push the safety switch back to the initial position.
5. Confirm the "Use system card?" prompt asking you to enable the service concept.

The data from the internal memory are copied to the system memory card.

Note

No prompt in the event of a defective system memory card

If the system memory card is defective, the "Use system card?" prompt is not displayed.

Replace the system memory card with a new SIMATIC HMI Memory Card ≥ 2 GB.

Result

The service concept is enabled. The data on the system memory card are continually updated automatically.

See also

Changing memory cards (Page 58)

4.2.2 Replacing HMI device

Requirement

- The service concept is enabled on the defective HMI device.
- A replacement device of the same type is available.

The slot for the system memory card is enabled on the replacement device (factory state).

If required, check the setting in the Control Panel under "OP Properties", "System Card" tab, see section "Disabling the service concept (Page 64)".

Procedure

Proceed as follows:

1. Switch off the HMI device.
2. Remove the defective HMI device.
3. Mount the replacement device.
4. Switch on the power supply of the replacement device.
5. Insert the system memory card of the defective HMI device in the corresponding slot of the replacement device.
6. Confirm the "Use system card?" prompt asking you to enable the service concept.

The content of the system memory card is copied into the internal memory of the HMI device. The HMI device is then restarted.

Note

No prompt in the event of a defective system memory card

If the system memory card is defective, the "Use system card?" prompt is not displayed.

Replace the system memory card with the system memory card of a different HMI device of the same type. If no other system memory card is available, proceed as follows:

- Update the operating system and transfer the HMI device image of the defective HMI device to the replacement device.
 - Transfer the project of the defective HMI device to the replacement device.
-

Result

The service concept is enabled. The data on the system memory card are continually updated automatically.

See also

Changing memory cards (Page 58)

4.2.3 Disabling the service concept

If you do not wish to continually back up the data of an HMI device on a memory card to ensure information security, you can disable the service concept.

Procedure

Proceed as follows:

1. Open the Control Panel.
2. Open the "OP Properties" dialog by using the "OP" icon.
3. Open to the "System Card" tab.

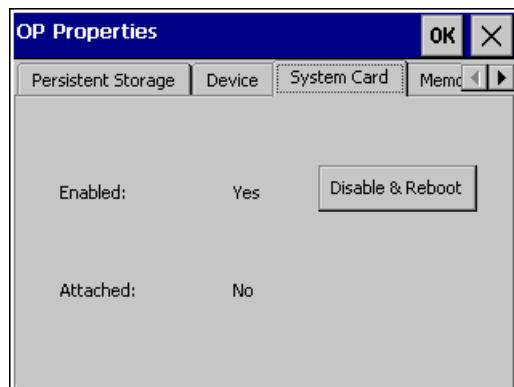

4. Disable the service concept with "Disable & Reboot".
5. Restart the HMI device.

Result

The service concept is disabled. You can enable the service concept again at any time in the "System Card" tab. If you do not wish to enable the service concept again, protect the Control Panel with a password.

See also

Changing password protection (Page 86)

4.3 Operating the device

4.3.1 Loader

Overview

The loader is displayed automatically when the HMI device is switched on. If there is a project on the HMI device, it is started automatically after a delay time. If you operate the loader during this delay time, the project no longer starts automatically.

If you stop on the HMI device Runtime or show the Windows CE Desktop, the loader will open automatically.

The following figure shows the loader without version information in the title bar:

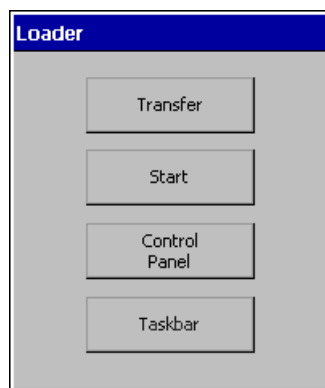

Function

In addition to the Control Panel, the loader is the central operator control on the HMI device. The Loader buttons have the following functions:

- Press "Transfer" to set the HMI device to "Transfer" mode.
You can only enable "Transfer" mode when transfer has been authorized in the Control Panel.
- Press "Start" to start an available project on the HMI device.
- Press "Control Panel" to open the Control Panel of the HMI device.
You can use the Control Panel to set the parameters for the HMI device, such as the settings for the transfer.
- Press "Taskbar" to activate the taskbar with the Windows CE Start menu open.

The following figure shows the open Start menu.

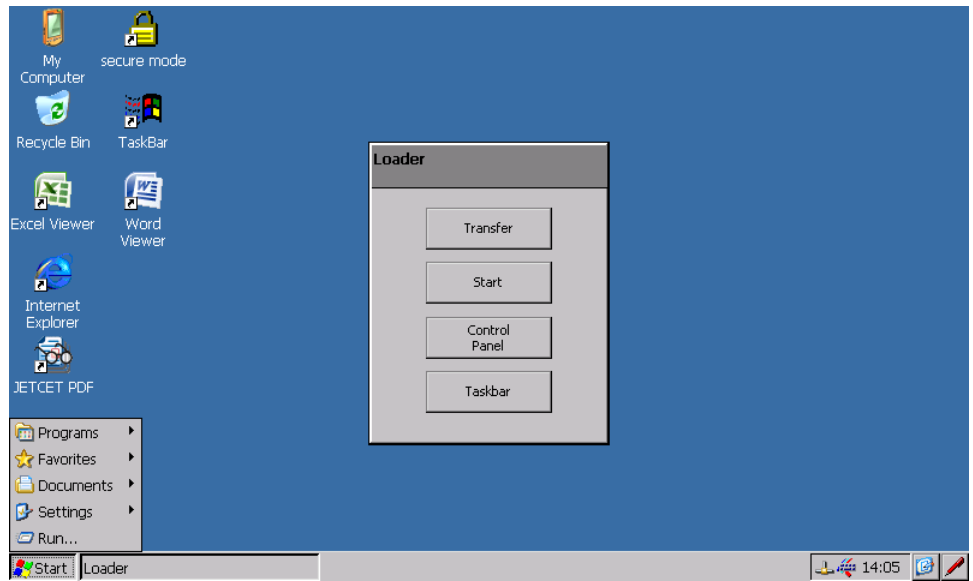

Depending on the software installed, other symbols may be displayed in the desktop's status bar.

Protection against unauthorized use

You can protect the control panel against unauthorized access by using a password. If the Control Panel protected with a password, "SecureMode" is automatically enabled. "SecureMode" additionally protects the taskbar and the Windows CE Desktop.

You can find additional information under Changing password protection (Page 86).

The "Transfer" and "Start" buttons can always be used without having to enter a password.

Password protection prevents maloperation. This increases the security of the system or equipment because settings for the current project can only be changed after entering the password.

NOTICE
Loss of data possible
If the password is no longer available, you can only cancel password protection by updating the operating system. All data on the HMI device will be deleted when you update the operating system.
Back up the HMI device's data.

4.3.2 Control Panel

The HMI device's Control Panel is similar to the control panel on a PC.

The following figure shows the Control Panel with an open dialog:

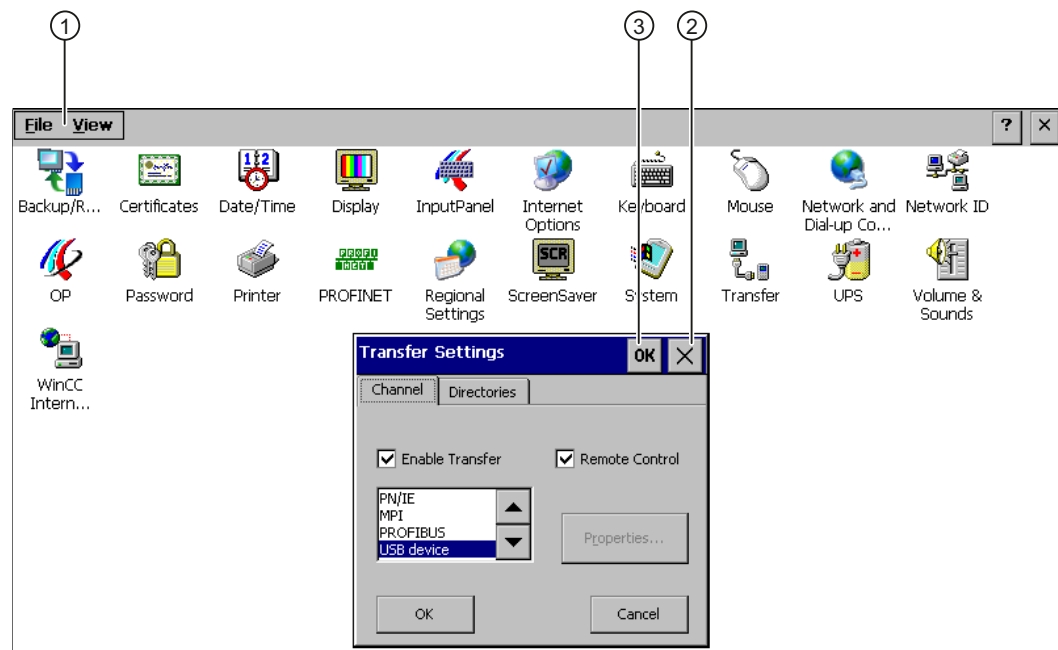

- ① Menu
- ② Discard entries and close dialog
- ③ Apply entries and close dialog

You can modify the following settings in the Control Panel:

- Date and time
- Time server
- Screen saver
- Regional settings
- Transfer settings
- Network settings
- PROFINET settings
- Delay time
- Password

Opening the Control Panel

You open the Control Panel using a button in the loader.

You can also open the Control Panel from the running project. To do this, configure the "OpenControlPanel" system function on an operating element event, for example, on a button.





4.3.3 Installed programs

Overview

The following programs are installed on the HMI devices by default:

- Viewers for documents in "PDF", "Excel" and "Word" format
- Media Player for Windows CE
- Internet Explorer for Windows CE

The programs can be found on the desktop or in the Start menu under "Programs". Each of these programs can also be opened from the HMI project.

Viewer	Icon	Readable file formats
PDF Viewer		PDF
Word Viewer		DOC, RTF
Excel Viewer		XL*
Media Player		WMA, MPEG
Internet Explorer		HTML

Viewer

All viewers share a Zoom function. The Excel Viewer also offers the following functions:

- Switch between spreadsheet tabs
- Split the spreadsheet
- Change line height and column width

Media Player

Media Player for Windows CE is installed on the HMI device. You can use the Media Player to play video sequences for servicing and maintenance, for example.

Note

The video file names may not contain any special characters except for "_".

Media Player for Windows CE and the Media Player version that can run on a PC differ in terms of functionality.

You can find additional information at the Microsoft website.

Internet Explorer

Internet Explorer for Windows CE and the Internet Explorer version which can run on a PC differ in terms of functionality.

Internet Explorer for Windows CE has separate proxy settings that are independent of the settings in the control panel of the HMI device.

You can find additional information at the Microsoft website.

4.3.4 Reference for system keys

You operate key HMI devices using the system keys.

Alphanumeric assignment of system keys

The following table shows the alphanumeric assignment of the system keys from "0" to "9":

Key	Alphanumeric assignment
1	<space>\@#%?!";;<>(){}€\$&%^°~ _1
2	ABCÄÅ2
3	DEFËÉ3
4	GHI4
5	JKL5
6	MNOÖ6
7	PRQRSß7
8	TUVÜ8
9	WXYZ9
0	+-*/=0



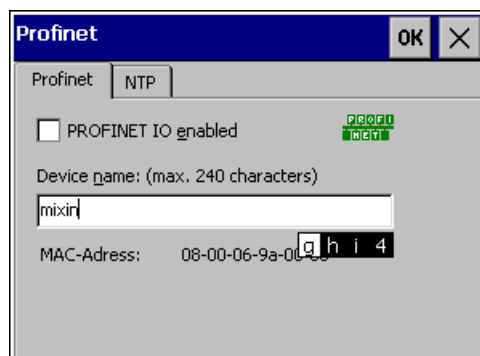













The characters available for input depends on the text box involved. The following figure shows the entry of an alphanumeric value using the system keys:



General functions

















You initiate functions on HMI devices with keys either using a key or keyboard shortcuts. With keyboard shortcuts, hold the first key down. Then press the second button.

The following table shows the system key functions that work both in the Control Panel and in the project:

Key or key combination	Function
	Switch between upper and lower case: <ul style="list-style-type: none"> • LED on: Upper case • LED off: Lower case
	Deletes the character left of cursor.
	Moves to the next operating element in the TAB order.
 	Moves to the previous operating element in the TAB order.
	Deletes the character right of cursor.
 	Toggles "overwrite" mode on or off. If "overwrite" mode is switched on, the characters are overwritten to the right of the cursor.
	Cancels an action, e.g.: <ul style="list-style-type: none"> • Discard entry and close dialog
	Executes a command, e.g.: <ul style="list-style-type: none"> • Operating buttons • Open dialog or select menu command • Apply value and close dialog
	Moves the cursor, selection or a controller in the specified direction.
	Move the cursor or selection one screen up.
	Move the cursor or selection one screen down.
	Press: Switches to another key mapping. Hold down: Switches between upper and lower case.
	General control function for use in keyboard shortcuts.
	General control function for use in keyboard shortcuts.









Operating Windows CE and the Explorer

The following table shows the system key functions when operating Windows CE and the Explorer:

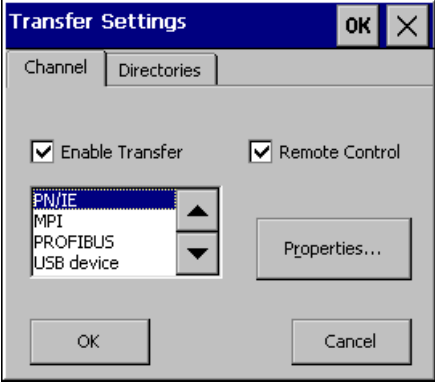
Key or key combination		Function
		Enables the taskbar and opens the Start menu.
		Displays the loader.
		Opens the task manager.
		Toggles between the Windows CE Desktop and the Explorer.
		Navigates to the directory above.
		Selects the first entry.
		Selects the last entry.
		Opens the shortcut menu.
		Displays the properties.





Operating the Control Panel and dialogs

The following table shows the system key functions when operating the Control Panel and dialogs:

Key or key combination	Function
	Activates the menu. To navigate the menu, use the cursor keys.
	Selects or clears a check box. The following figure shows the "Enable Transfer" and "Remote Control" check boxes: <div style="border: 1px solid black; padding: 5px; margin: 10px 0;">  </div>
 	Opens a drop-down list box.
 	Selects a list item without closing the dialog.
	Navigates through tabs or options. Activate the tab or the options, in each case with <TAB>.

Operating a project

The following table shows the system key functions when operating an ongoing project:

Key or key combination	Function
	Acknowledges the currently displayed error alarm or all the alarms of an alarm group as group acknowledgment. A lit LED indicates unacknowledged fault alarms.
	Calls up the configured infotext for an operating element. When the LED is lit, it indicates that an infotext is available.
	Enables the operation of an operating element.
 	Position the cursor within an I/O field.

See also

Input of values (Page 158)

Entering and editing numeric values (Page 159)

Entering or changing alphanumeric values (Page 160)

4.3.5 Entering values with system keys

The system keys of the HMI devices have the same operating concept as the keypad of a cell phone. Each system key assigned with several letters and symbols of the alphabet and each is assigned a number. When you press a key system long enough, the number is automatically inserted.

The following figure shows the entry of an alphanumeric value using the system keys:

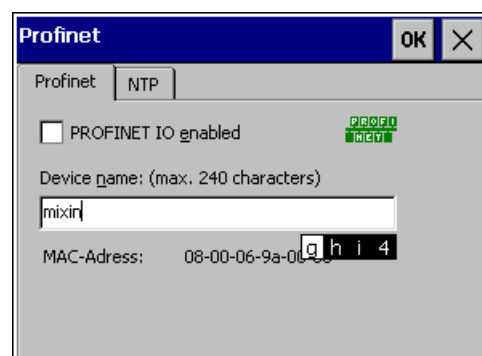

Requirement

Cursor must be in the text box.

Procedure

Proceed as follows:

1. Press the respective key repeatedly until the desired character is selected in the preview.

The mapping of system keys to letters and numbers can be restricted within a given context.

The desired character is applied in about one second or immediately after pressing a different button.

2. To toggle between upper and a lower case, press <a/A>.



All subsequent characters are written either in upper or lower case.

3. To navigate within the given character string, use the cursor keys.
4. If you enter values in the Control Panel, you can apply them with <ENTER> or <TAB>:
 - <ENTER>: Closes the dialog.
 - <TAB>: Navigates to the next operating element within the dialog.
5. If you enter values in the project, you can apply them with <ENTER>.

Result

The value is entered.

See also

Input of values (Page 158)

Entering and editing numeric values (Page 159)

Entering or changing alphanumeric values (Page 160)

4.3.6 Using the screen keyboard

Introduction

Use the screen keyboard to enter alphanumeric values. If you connect an external keyboard to an HMI device with a touch screen, the screen keyboard is not displayed. You operate the screen keyboard like a normal keyboard.

If you touch an operating element with a value, the screen keyboard opens automatically. Depending on the operating element, either the alphanumeric or numerical screen keyboard opens.

The appearance and the keyboard layout of the screen keyboard depend on the HMI device used.

Depending on the configuration in the Control Panel, you can move the screen keyboard or change its size.

Screen keyboard of the 4" model

The following figure shows the appearance of the screen keyboard of the 4" model:

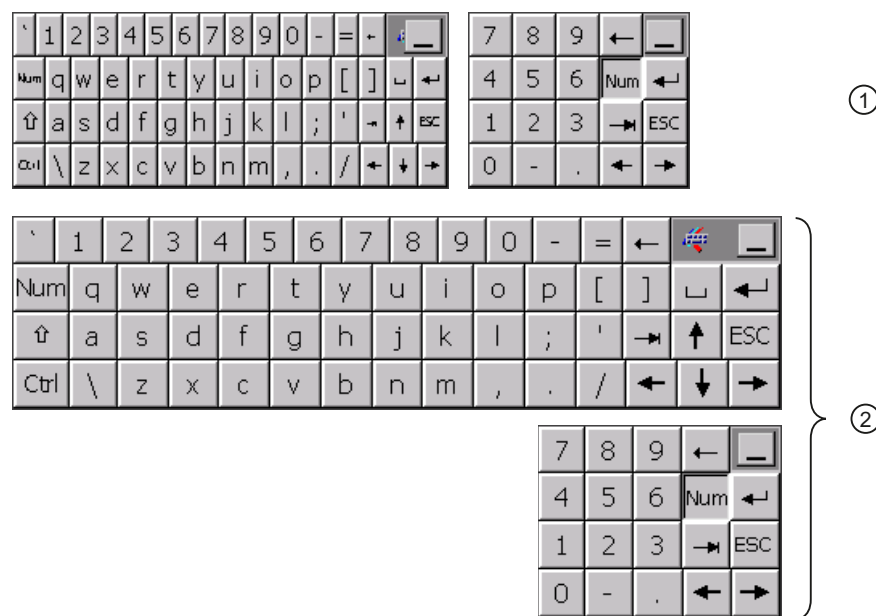

- ① Screen keyboard with numeric keypad for mounting in vertical format (Touch HMI devices only)
- ② Screen keyboard with numerical keypad for mounting in horizontal format

Screen keyboards of the 7" and 9" models

The following figure shows the appearance of the screen keyboards of the 7" and "9 models:

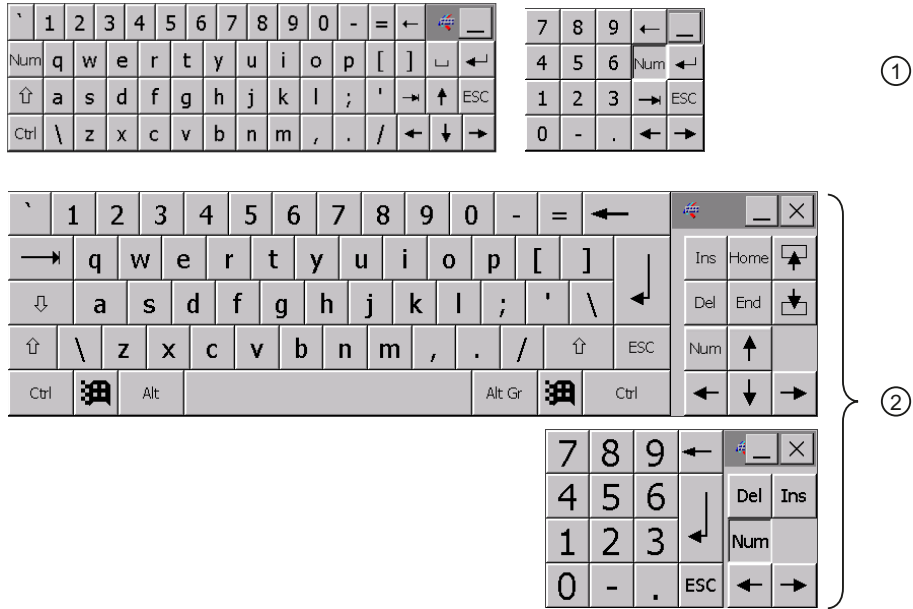

- ① Screen keyboard with numeric keypad for mounting in vertical format (Touch HMI devices only)
- ② Screen keyboard with numerical keypad for mounting in horizontal format

12" to 22" screen keyboards

The following figure shows the appearance of the screen keyboard of the 12" model:

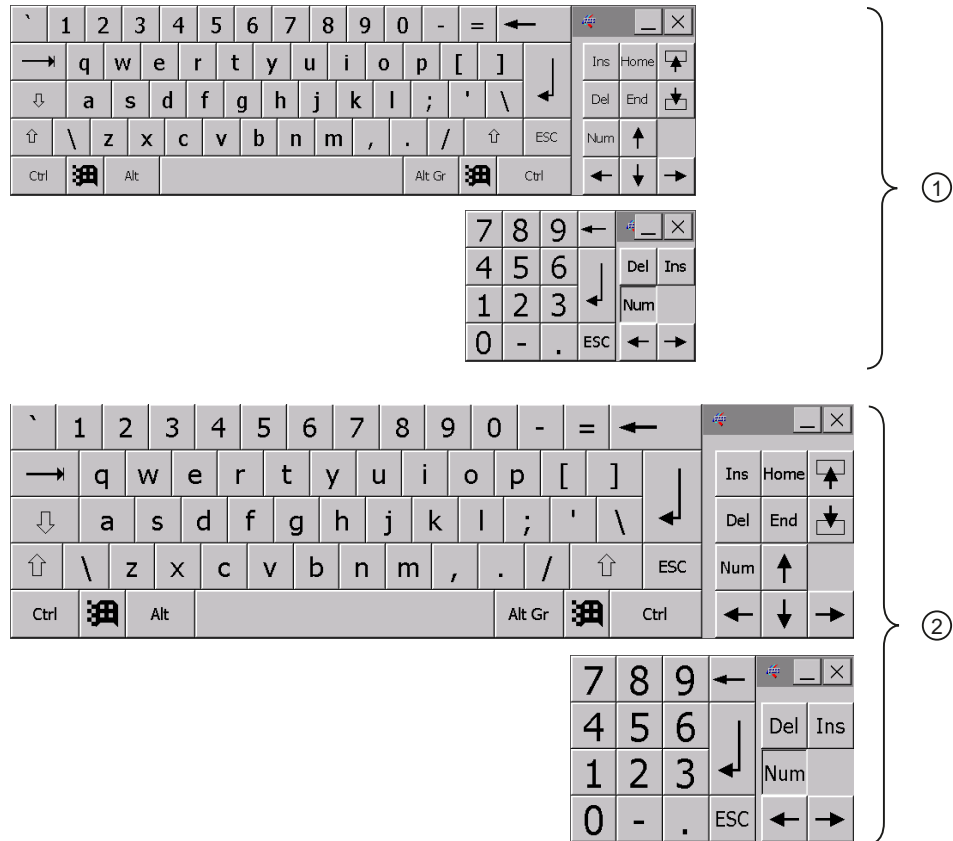

- ① Screen keyboard with numeric keypad for mounting in vertical format (Touch HMI devices only)
- ② Screen keyboard with numerical keypad for mounting in horizontal format

Requirement

The screen keyboard is open.

Procedure

Proceed as follows:

1. Enter the desired value using the keys.
2. Display the available special characters if needed using <Alt Gr>.



3. Display the numerical keypad if needed using <Num>.



4. To complete entry:
 - If you want apply the selected value, press "Return".



- If you want discard the selected value, press "Esc".



Result

The screen keyboard closes. Depending on the key used, the entered value is applied or discarded.

See also

Input of values (Page 158)

Entering and editing numeric values (Page 159)















Entering or changing alphanumeric values (Page 160)









4.4 Configuring the device

4.4.1 Reference for functions

Overview of functions

The following table shows the settings in the Control Panel.

Icon	Function
	Saving to external storage device (backup) (Page 131) Restoring from external storage device (Page 133)
	Importing and deleting certificates (Page 130)
	Setting the date and time (Page 87)
	Changing monitor settings (Page 91)
	Configuring the screen keyboard (Page 80)
	Changing general Internet settings (Page 126)
	Setting the proxy server (Page 127)
	Changing privacy settings (Page 128)
	Setting the character repeat (Page 82)
	Setting the double-click (Page 83)
	Changing the network configuration (Page 119)
	Changing the logon data (Page 123)
	Backup registry information (Page 90)
	Displaying information about the HMI device (Page 101)
	Restarting the HMI device (Page 99)
	Calibrating the touch screen (Page 83) ¹
	Activate memory management (Page 135)
	Enabling the service concept (Page 62)
	Changing password protection (Page 86)
	Changing the printer properties (Page 96)

Icon	Function
	Enabling PROFINET services (Page 109)
	Time server configuration (Page 111)
	Changing regional settings (Page 89)
	Setting the screen saver (Page 94)
	Displaying system properties (Page 102)
	Displaying memory distribution (Page 103)
	Setting the device name of the HMI device (Page 118)
	Configuring the data channel (Page 113)
	Setting the delay time (Page 105)
	Setting storage location (Page 104)
	Changing MPI/PROFIBUS DP settings (Page 115)
	Setting the uninterruptible power supply (Page 106)
	State of uninterruptible power supply (Page 108)
	Enabling sound and setting sound volume (Page 97)
	Assigning sound to an event (Page 98)
	Changing e-mail settings (Page 124) ²
	Configuring Telnet for remote control (Page 125)

¹ For HMI devices with touch screen only

² Additional tabs may appear in the "WinCC flexible Internet Settings" dialog. This depends on the options that have been enabled for network operation in the project.

See also

Overview of network operation (Page 117)

4.4.2 Changing settings for operation

4.4.2.1 Configuring the screen keyboard

The details provided below will explain how the screen keyboard can be displayed and positioned.

Requirement

The Control Panel is open.

Procedure

Proceed as follows:

1. Open the "Siemens HMI Input Panel - Options" dialog with the "InputPanel". icon.

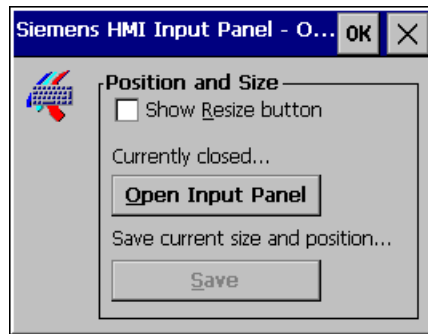

2. If you want to change the size of the screen keyboard, select the "Show Resize Button" check box.

The next time you open the screen keyboard, the icon for changing the size of the screen keyboard will appear.



3. Use "Open Input Panel" to open the screen keyboard.
4. If needed, toggle between the numerical and alphanumerical screen keyboard using "<Num>".

Beginning with the 12" models, the numerical keypad is integrated in the screen keyboard.



5. To change the position of the screen keyboard:
 - Move the mouse pointer over an empty space between the keys.
 - Move the screen keyboard using drag-and-drop.
6. To change the size of the screen keyboard:
 - Move the mouse pointer to the "Resize" icon.
 - Change the size of the screen keyboard using drag-and-drop.
7. Save the settings of screen keyboard with "Save" if needed.
8. Confirm your entries with "OK".

Result

The screen keyboard settings have been modified.

See also

Reference for functions (Page 79)

4.4.2.2 Setting the character repeat

The details provided below will explain how to set the character repetition and the associated delay for the keyboard or screen keyboard.

Requirement

The Control Panel is open.

Procedure

Proceed as follows:

1. Open the "Keyboard Properties" dialog with the Keyboard icon.

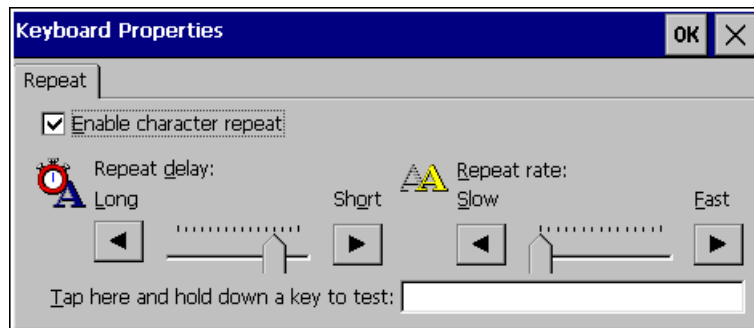

2. If you want to enable character repetition, select the "Enable character repeat" check box.
3. Change the delay time under "Repeat delay" if needed.
4. Change the repetition rate under "Repeat rate" if needed.
5. Check the settings under "Tap here...":
 - If you use a touch HMI device, touch the test field.
The screen keyboard opens.
 - If you use a key HMI device, select the test field.
 - Press an alphanumeric key and keep the key pressed down.
 - Check the implementation of the character repetition and the rate of the character repetition in the test field.
 - If necessary, correct the settings and repeat the test.
6. Confirm your entries with "OK".

Result

The character repetition and delay are set.

See also

Reference for functions (Page 79)

4.4.2.3 Setting the double-click

You can start applications in the Control Panel and in Windows CE with a double-click. A double-click corresponds to two brief touches in sequence.

In the "Mouse Properties" dialog, make the following adjustments for operation with the touch screen or external mouse:

- Interval between two touch contacts on the touch screen
- Interval between mouse clicks

Requirement

The Control Panel is open.

Procedure

Proceed as follows:

1. Open the "Mouse Properties" dialog with the Mouse icon.
2. Click the pattern twice.



After the second click, the grid is shown in inverse colors. The white boxes change to gray. The time before the second click is saved.



3. To test the double-click, click twice in succession on the icon.

If the double-click is recognized, the representation of the icon changes.



4. If the settings are not optimal, repeat the double-click on the sample.
5. Confirm your entry with "OK".

Result

The double-click adjustment is completed.

See also

Reference for functions (Page 79)

4.4.2.4 Calibrating the touch screen

Depending on the mounting position and viewing angle, parallax may occur on the touch screen. In order to prevent operating errors as a result, calibrate the touch screen again in the startup phase or during runtime.

This functionality is only available for Touch HMI devices.

Requirement

The Control Panel is open.

Procedure

Proceed as follows:

1. Open the "OP Properties" dialog with the "OP" icon.
2. Open to the "Touch" tab.



3. Calibrate the touch screen with "Recalibrate".

The following dialog opens:

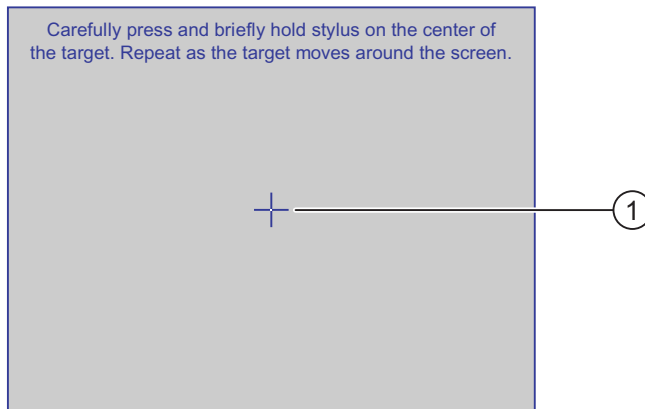

4. 4" to 12" models: Briefly touch the center of the calibration crosshairs. The calibration crosshairs appear at the next position.
15" to 22" models: Touch the center of the calibration crosshairs until they appear at the next position.

5. Proceed as in step 4 for all four following positions.

Once you have touched all the positions of the calibration crosshairs, the following dialog appears:

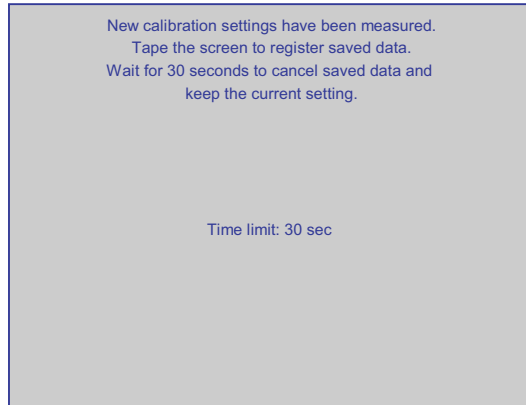

6. To apply the calibration, touch the screen within 30 seconds.
Otherwise, the calibration is discarded and the original calibration continues to be used.
When calibration is completed, the "OP Properties" dialog is displayed again.
7. Close the dialog with "OK".

Result

The touch screen of the HMI device is calibrated.

See also

Reference for functions (Page 79)

4.4.3 Changing password protection

You can protect access to the Control Panel with a password. If you configure password protection, "SecureMode" is automatically enabled for the HMI device. "SecureMode" additionally protects the taskbar and the Windows CE Desktop against unauthorized access.

Requirement

The Control Panel is open.

NOTICE
Password not available
If the password is no longer available, the following operator controls are no longer enabled:
<ul style="list-style-type: none">• Control Panel• Taskbar• Windows CE Desktop
All data on the HMI device will be deleted when you update the operating system!
Therefore use the password to protect against loss.

Note

The following characters cannot be used in passwords:

- Blank
- Special characters * ? . % / \ ' "

Procedure

Proceed as follows:

1. Open the "Password Properties" dialog with the Password icon.

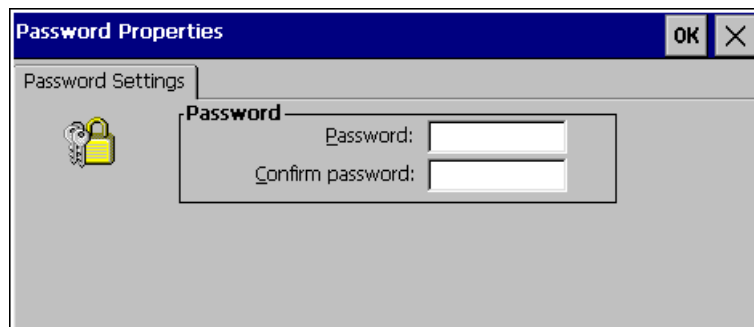

2. Enter the password under "Password".
3. Repeat the password under "Confirm password".
4. Confirm your entry with "OK".

Result

The "secure mode" label is displayed on the Windows CE Desktop:

If you attempt to operate the Control Panel, taskbar or Windows CE Desktop, you are prompted for a password. "SecureMode" is then switched off.

"Switching "SecureMode" on again

To switch SecureMode back on, double-click the SecureMode icon on the Windows CE Desktop.



Removing password protection and "SecureMode"

To remove password protection and "SecureMode", delete the settings under "Password" and "Confirm password".

See also

Reference for functions (Page 79)

4.4.4 Changing HMI device settings

4.4.4.1 Setting the date and time

The HMI device features an internal buffered clock. You can set the date and time manually via the Control Panel. The HMI device must be restarted in the following cases:

- You have changed the time zone setting.
- You have changed the "Daylight savings time currently in effect" setting.

Automatic acquisition of the date and time

Alternatively, you can set the date and time automatically:

- Specify one or more time servers.
- Synchronize the time with the PLC.

Requirement: Project and control program are configured accordingly.

You can find additional information on this subject in the documentation for WinCC.

NOTICE

Time-dependent reactions

You have to synchronize the date and time when time-controlled responses are triggered in the PLC by the HMI device.

Requirement

The Control Panel is open.

Procedure

Proceed as follows:

1. Open the "Date/Time Properties" dialog with the "Date/Time Properties" icon.

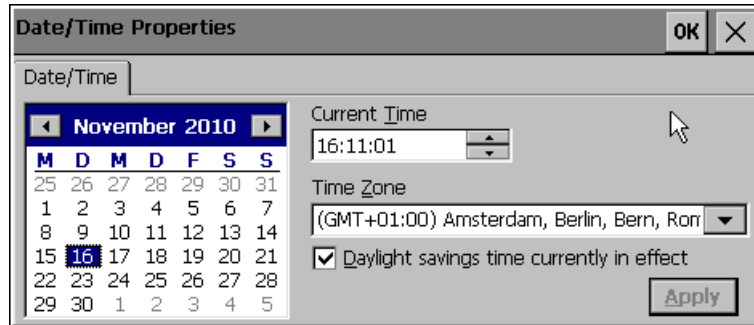

2. Select the appropriate time zone for the HMI device under "Time Zone".
3. Confirm your entry with "Apply".

The time of day shown under "Current Time" is adjusted correspondingly to the selected time zone.

4. Set the date in the calendar.
5. Set the current time of day under "Current Time".
6. Confirm your input by clicking on the "Apply" button.

The values you have set are now in effect.

7. To change between standard time and daylight savings time:
 - Select "Daylight savings time currently in effect" to switch from standard time to daylight savings time.
 - Clear "Daylight savings time currently in effect" to switch from daylight savings time to standard time.
 - Confirm your entry with "Apply".

The time is moved forward one hour (daylight savings time) or back one hour (standard time).
8. Confirm your entries with "OK".

Result

The settings for the data and time of day have now been changed.

Alternative procedure

Alternatively, you can also switch between standard time and daylight savings time while the project is running. To do this, configure the "SetDaylightSavingTime" system function on the even of an operator control, for example, on a button.

See also

- Reference for functions (Page 79)
- Synchronizing the time via the time server (Page 111)

4.4.4.2 Changing regional settings

In different countries, for example, the date, time and decimal points are displayed differently. You can adjust this display to meet the requirements of different regions.

The country-specific settings apply to the current project. If the project language is changed, the country-specific settings are also changed.

Requirement

The Control Panel is open.

Procedure

Proceed as follows:

1. Open the "Regional and Language Settings" dialog with the Regional Settings icon.
2. Open to the "Regional Settings" tab.

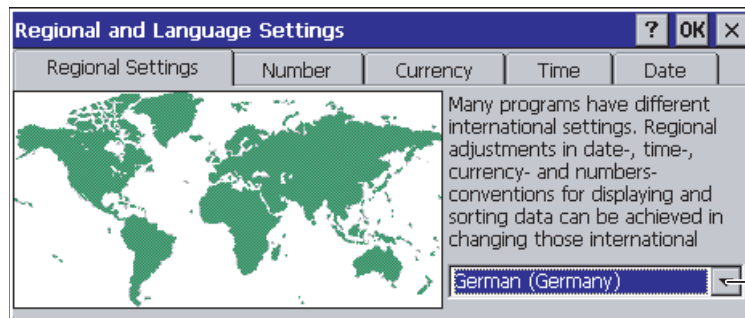

3. Select the region.
4. Open the "Number", "Currency", "Time" and "Date" tabs and make desired settings for the region.
5. Confirm your entries with "OK".

Result

The HMI device's regional settings have been changed.

See also

- Reference for functions (Page 79)

4.4.4.3 Backup registry information

You can install and uninstall your own programs on the HMI devices under Windows CE. You need to back up the registry settings after installation or removal.

You can back up the following data to the internal memory:

- Registry Information
- Temporary files

"Temporary files" are all files which are not saved under "\flash". Temporary files are no longer available after restarting the HMI device.

Exception: The files in the "\Temp" directory are not backed up.

Restoring the file system of a memory card

If a memory card other than the SIMATIC HMI Memory Card ≥ 2 GB is used, the file system on the memory card may be damaged, for example in the event of a power failure. The HMI device detects the defective file system on start-up or when the memory card is inserted. The HMI device can, on request, attempt to restore damage files. Note that not all damaged files may be able to be restored.

Requirement

The Control Panel is open.

Procedure

Proceed as follows:

1. Open the "OP Properties" dialog with the OP icon.
2. Open to the "Persistant Storage" tab.

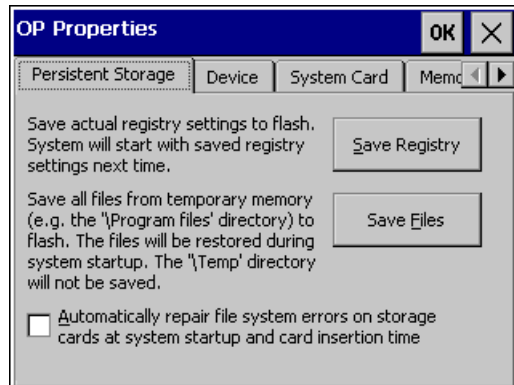

3. To back up registry entries to the internal memory of the HMI device, press "Save Registry".
4. To back up files from the temporary section of the internal memory of the HMI device, press "Save Files".
5. When a corrupted file system is to be restored automatically on the memory card, select "Automatically repair file system errors ...".
Otherwise, a corrupted file system will only be restored when requested.
6. Confirm your entries with "OK".

Result

Registry entries and files from the temporary memory are saved in the internal memory of the HMI device. The HMI device uses the saved registry entries the next time it starts. The saved files are written back into the temporary memory.

The HMI device uses the saved registry information the next time it starts. The temporary files are copied back.

See also

Reference for functions (Page 79)

4.4.4.4 Changing monitor settings

Adapting the screen settings

The screen settings on the HMI device must match the settings in the project. To achieve a high color depth on the HMI device, use objects with the same color depth on your configuring PC. Objects with higher color depth need more computing power on the HMI device. If you are monitoring and controlling time-critical processes, use a lower color depth during configuration.

NOTICE
Changed screen orientation takes effect only after reboot
With touch HMI devices, a change to the screen orientation only takes effect after you reboot the HMI device. The configuration file is also deleted. Adapt the configuration to the new screen orientation and transfer the project again to the HMI device.
Therefore, do not change the screen orientation in ongoing plant operation.

Requirement

The Control Panel is open.

Procedure

Proceed as follows:

1. Open the "Display Properties" dialog with the Display icon.
2. To change the color depth, open the "Settings" tab.

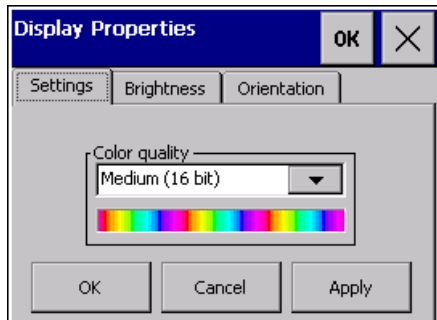

- Select the desired color depth under "Color Quality".
- Confirm with "Apply".

A change of the color depth only takes effect after rebooting the HMI device.

3. To change the brightness, open the "Brightness" tab. The figure below shows the TP1500 Comfort "Brightness" tab as an example.

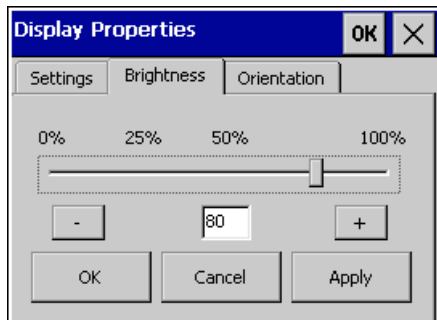

- Change the brightness to a value between the minimum and 100%.
- Confirm with "Apply".

The brightness is adapted.

4. To change the screen orientation of a touch HMI device, open the "Orientation" tab.

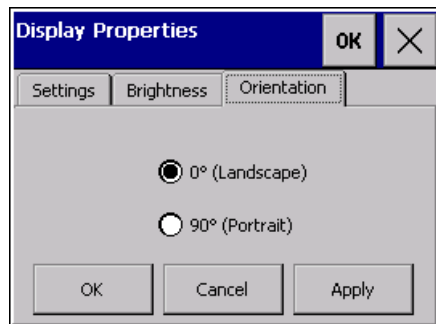

- If you installed the HMI device vertically, select "Portrait".
 - If you installed the HMI device horizontally, select "Landscape".
 - Confirm with "Apply".
5. Close the dialog with "OK".

Result

The screen settings have been changed.

When you change the screen orientation, the setting only takes effect after you reboot the HMI device. The configuration file on the HMI device is deleted. Transfer the project from the configuring PC to the HMI device.

See also

- Restarting the HMI device (Page 99)
- Reference for functions (Page 79)

4.4.4.5 Setting the screen saver

You can set the following time intervals on the HMI device:

- Automatic reduction of the screen backlighting
- Automatic activation of the screensaver

The configured function is automatically activated if the HMI device is not operated within the specified period of time.

<p>NOTICE</p> <p>Reduce backlighting</p> <p>The brightness of the backlighting decreases incrementally during its operational life.</p> <p>In order to not shorten the operational lifetime of the backlighting unnecessarily, activate the backlighting reduction.</p> <p>Activating the screen saver</p> <p>Screen contents may occasionally leave a burn-in effect in the background if they appear too long.</p> <p>This burn-in effect will automatically disappear after a certain amount of time if the screensaver is activated, for example. The longer the same content is displayed on the screen, the longer it will take for the burn-in effect to disappear.</p> <p>Generally, you should always activate the screen saver.</p> <p>The "Blank Screen" setting is used to switch off backlighting.</p>
--

Requirement

The Control Panel is open.

Procedure

Proceed as follows:

1. Open the "Screensaver" dialog with the ScreenSaver icon.

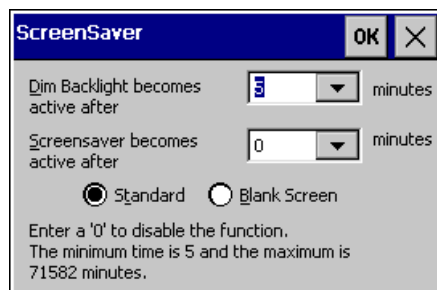

2. Enter the number of minutes before backlighting is to be reduced and the screen saver is to be activated.

Value range in minutes: 5 to 71582. "0" disables the feature.

3. Select the type of screen saver:
 - To display an animation, select "Standard".
 - To switch off backlighting, select "Blank Screen".Backlighting is completely switched off. This will increase the service life of the screen. Energy consumption is reduced.
4. Confirm your entries with "OK".

Result

The screen saver and the reduced backlighting for the HMI device is set.

Switching on backlighting again

If you selected "Blank Screen", you can switch backlighting on again in two ways:

- Set the brightness to the maximum value set in the HMI device:
 - Touch screen device: Briefly touch the touch screen
 - Key device: Briefly press any key
- Increase brightness incrementally:
 - Touch screen device: Touch the touch screen until the required brightness is reached
 - Key device: Press <Up> until the required brightness is reached.



The function associated to the key or button will not be executed when the brightness is set.

See also

Reference for functions (Page 79)

Changing monitor settings (Page 91)

4.4.4.6 Changing the printer properties

The HMI device can print on local printers or network printers. You can print hardcopies and reports on a network printer. Line printing of alarms is only possible on a local printer.

You can find the list of current printers and required settings for HMI devices in the Internet at Printers approved for SIMATIC Panels and Multi Panels (<http://support.automation.siemens.com/WW/view/en/11376409>).

Requirement

The Control Panel is open.

Procedure

Proceed as follows:

1. Open the "Printer Properties" dialog with the Printer icon.

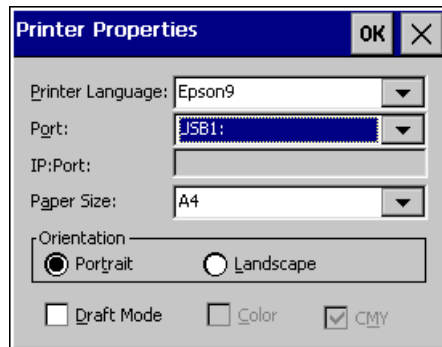

2. Select a printer under "Printer Language".
3. Select the port for the printer under "Port".
4. Enter the network address of the printer "Network", based on the selected port.
5. Select a paper format under "Paper Size".
6. Set the orientation of the printout under "Orientation":
 - "Portrait" for portrait
 - "Landscape" for landscape
7. Set the print quality:
 - To print in draft quality, select "Draft Mode".
 - To print in color, select "Color".
8. Confirm your entries with "OK".

Result

The settings for the printer have now been changed.

See also

Reference for functions (Page 79)

4.4.4.7 Enabling sound and setting sound volume

You can activate an acoustic feedback for keyboard and touch screen operations. A sound is emitted with each touch or activation of a key.

Requirement

The Control Panel is open.

Note

If you deactivate the settings under "Enable sounds for", no more acoustic signals will be emitted during inadvertent operations.

Procedure

Proceed as follows:

1. Open the "Volume & Sounds Properties" dialog with the Volume & Sounds icon.
2. Open to the "Volume" tab.

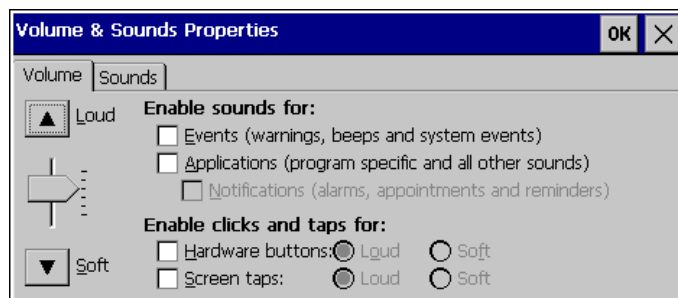

3. To output alarms of the HMI device with additional acoustics, select the desired option under "Enable sounds for":
 - "Events": Warnings and system events
 - "Applications": Program-specific events
 - "Notifications": Notifications
4. Change the volume level of the alarms using "Loud" and "Soft" if needed.
5. To output operator feedback with additional acoustics, select the desired option under "Enable clicks and taps for":
 - "Hardware buttons": Feedback when using keys
 - "Screen taps": Feedback when touch control
6. Use "Loud" and "Soft" to select between loud and quiet operator feedback.
7. Confirm your entries with "OK".

Result

The properties of the acoustic operation feedback are now set up.

See also

Reference for functions (Page 79)

4.4.4.8 Assigning sound to an event

When acoustic feedback is activated, a sound is used to report an event. You can select the sound to reflect the event. The sound is output by the loudspeaker of the HMI device.

Note

Acoustic feedback with sounds is support from the 7" models.

Requirement



The Control Panel is open.

Procedure

Proceed as follows:

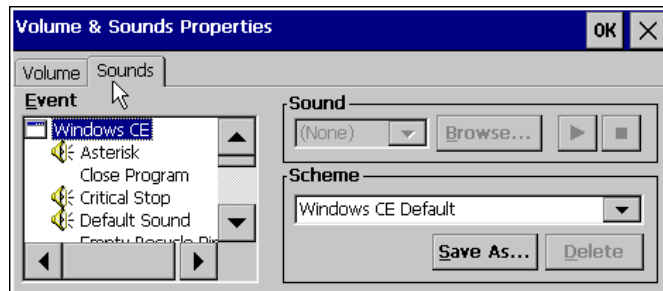
1. Open the "Volume & Sounds Properties" dialog with the Volume & Sounds icon.
2. Open the "Sound" tab.



3. Under "Event", select the event to which you wish to assign a sound.
Events that already have a sound assigned are labeled with a speaker symbol.
4. Select the desired sound for the event under "Sound":
 - Select either a standard Windows sound or use "Browse" to select a ".WAV" file from the file system.
 - Test the sound with "Play" if needed.

 - Stop the output "Stop" if needed.

5. Confirm your entries with "OK".

Result

The sound is set for acoustic feedback on operations.

See also

Reference for functions (Page 79)

4.4.4.9 Restarting the HMI device

Required restart

The HMI device must be restarted in the following cases:

- You have enabled or disabled PROFINET IO services.
- You have changed the time zone setting.
- You have changed the automatic daylight savings and standard setting
- You have changed the color depth of the screen.
- You have changed the orientation of the screen (Touch HMI devices only).

NOTICE

Data loss when the HMI device is restarted

All volatile data is lost when the HMI device is restarted.

Check the following:

- The project on the HMI device is complete.
- No data is being written to the internal memory.

Requirement

- The Control Panel is open.
- All applications and files are closed.
- If you want to reset the HMI device to the factory settings: The HMI device is connected to the configuring PC via Ethernet.

Procedure

1. Open the "OP Properties" dialog with the OP icon.
2. Open the "Device" tab.

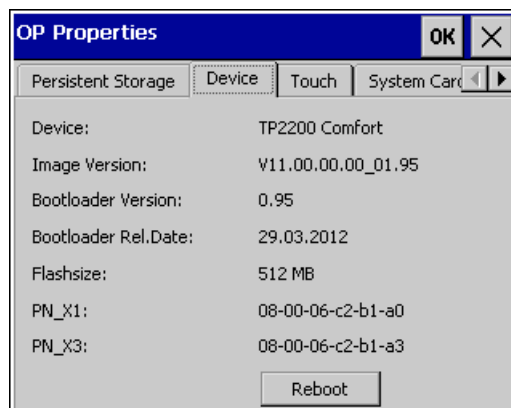

3. Use "Reboot" to start the selection process for restart the HMI device.

The following alarm is displayed:



4. To restart the HMI device, press "Reboot".
All unsaved data are lost when you reboot.
5. To set the HMI device to the mode for bootstrapping, press "Prepare for Restart".
6. To cancel the restart of the HMI device, press "NO".

Result

The HMI device restarts.

If you select "Prepare for Reset", you can reset the HMI device to factory settings with ProSave or WinCC. If you do not reset the HMI device to the factory settings, the HMI device restarts after 10 minutes.

Further information on this can be found in the section "Updating the operating system of the HMI device (Page 147)".

See also

Reference for functions (Page 79)

4.4.4.10 Displaying information about the HMI device

You will need specific information about the device if you contact Technical Support.

Requirement

The Control Panel is open.

Procedure

Proceed as follows:

1. Open the "OP Properties" dialog with the OP icon.
2. Open the "Device" tab.

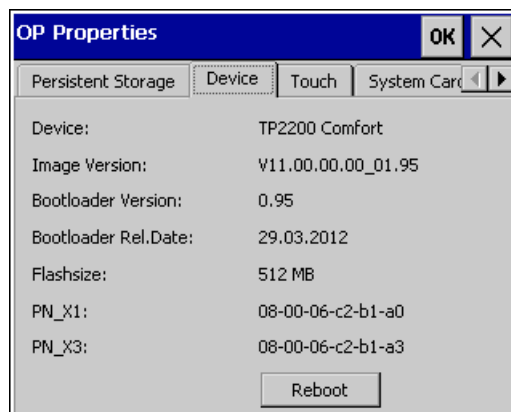

Comfort devices of 15" or more come with the second network adapter "PN_X3".

Result

The device-specific information is displayed in the dialog:

- HMI device name
- Version number of the installed operating system image
- Version number and release date of the boot loader
- Size of internal flash memory

Note

The size of internal flash memory is not equivalent to application memory available for a project.

- MAC address of the HMI device

See also

Restarting the HMI device (Page 99)

Reference for functions (Page 79)

4.4.4.11 Displaying system properties

The general system-specific information provides you with information about the processor, operating system and memory.

The system properties are device-specific and may therefore deviate from that of your HMI device.

Requirement

The Control Panel is open.

Procedure

Proceed as follows:

1. Open the "System Properties" dialog with the "System" icon.
2. Open the "General" tab.

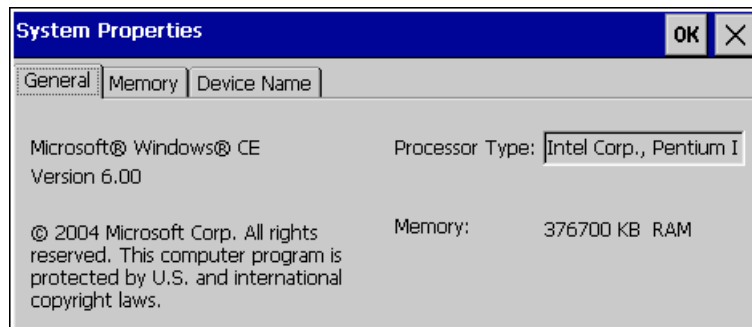

Result

The system properties are displayed.

See also

Reference for functions (Page 79)

4.4.4.12 Displaying memory distribution

The "Memory" system-specific information provides you with information about the distribution and size of the memory in the HMI device.

NOTICE

"Memory" tab

Do not change the memory distribution in the "Memory" tab.

Requirement

The Control Panel is open.

Procedure

1. Open the "System Properties" dialog with the System icon.
2. Open the "Memory" tab.

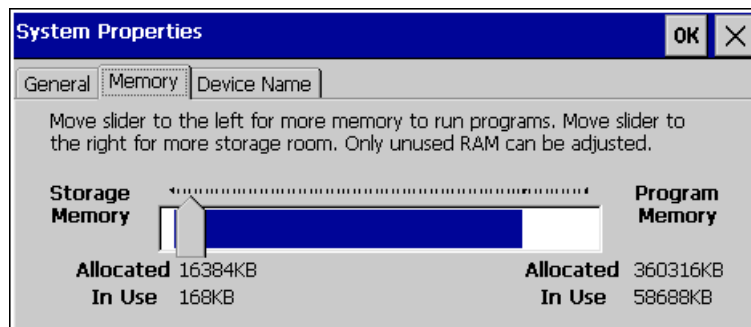

3. Determine the HMI device's current memory structure
4. Close the dialog with "OK".

See also

Reference for functions (Page 79)

4.4.5 Setting storage location

There are various storage locations available for storing the compressed source file of your project, for example, the external memory card or a network drive.

Requirement

The Control Panel is open.

Procedure

1. Open the "Transfer Settings" dialog with the Transfer icon.
2. Open the "Directories" tab.

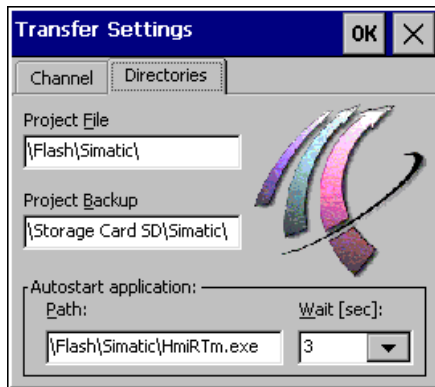

NOTICE

Settings under "Project File" and "Path"

The project may not open the next time the HMI device is started if changes are made in the "Project File" and "Path" text boxes.

Do not change the entries in the "Project File" and "Path" text boxes.

3. Select a memory location under "Project Backup".
4. Confirm your entries with "OK".

The dialog closes.

Result

The storage location for the HMI device is now set.

See also

Reference for functions (Page 79)

4.4.6 Setting the delay time

To specify the starting characteristics of the project after switching on the HMI device, you can set a delay time. The delay time is a period in which the loader is displayed on the HMI device. If you operate the loader during this time period, the project no longer starts automatically.

Requirement

The Control Panel is open.

Procedure

Proceed as follows:

1. Open the "Transfer Settings" dialog with the Transfer icon.
2. Open the "Directories" tab.

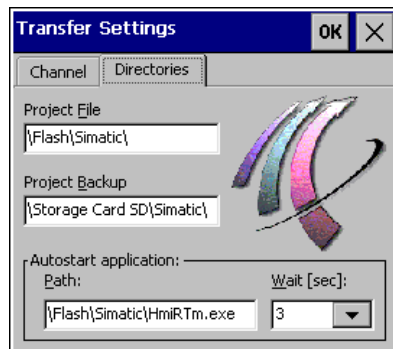

NOTICE

Settings under "Project File" and "Path"

The project may not open the next time the HMI device is started if changes are made in the "Project File" and "Path" text boxes.

Do not change the entries in the "Project File" and "Path" text boxes.

3. Select the desired delay time under "Wait [sec]".
 - "0": The Loader is not displayed. The project is then started immediately when the HMI device is switched on. To open the Control Panel of the HMI device, configure an operating element to close Runtime in the project.
 - "1" to "5": The project starts when the delay time comes to an end.
 - "forever": The project does not start automatically. The loader is displayed when the HMI device is switched on.
4. Confirm your entry with "OK".

Result

The delay time for the HMI device is now set.

See also

Reference for functions (Page 79)

4.4.7 Setting the uninterruptible power supply

A UPS ensures that the HMI device is shut down in a controlled manner after a configurable buffer time in the event of a power failure. This avoids the loss of data. Connect the UPS to the USB port of the HMI device.

You can also configure a message or controlled shutdown of the HMI device if the UBS port is faulty.

SITOP DC UPS modules as of a rated power of 6 A, for example 6EP1931-2DC42 are supported as an uninterruptible power supply.

Requirement

- The Control Panel is open.
- The UPS is connected to the 24-V input and to the HMI device's USB port.
- The "Uninterruptable Power Supply (UPS) with USB support" option is transferred to the HMI device with ProSave.

Procedure

Proceed as follows:

1. Open the "UPS Properties" dialog with the UPS icon.
2. Open the "Configuration" tab.

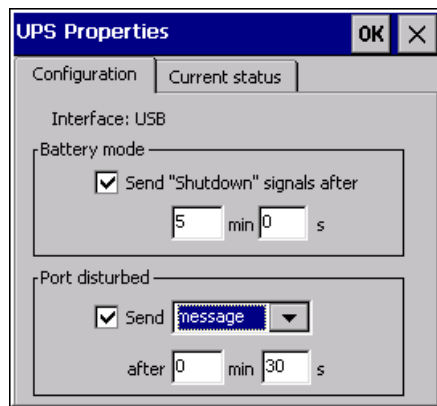

3. If a controlled shutdown of the HMI device is to be performed following interruption of the power supply:
 - Select "Battery mode".
 - Under "min" and "s", specify the time after which the Runtime software application is automatically closed on the HMI device.

CAUTION

Undefined device status if UPS buffer time is insufficient

If the UPS used can not sustain the power supply for the configured time period, the HMI device is not shut down in a controlled manner. This may result in damage to the HMI device.

Ensure that the UPS employed can sustain the power supply over the set time period.

4. If the port to which the UPS is connected is faulty and the HMI device is supposed to respond to this:
 - Select "Port disturbed".
 - Select "message" if you want to receive a message.
 - Select "shutdown" if the HMI device is to be shut down in a controlled manner.
 - Under "min" and "s", specify the time after which the message is displayed or the Runtime software application is automatically closed on the HMI device.

Result

Port monitoring for the UPS is set.

See also

State of uninterruptible power supply (Page 108)

Reference for functions (Page 79)

Connecting the power supply (Page 44)

4.4.8 State of uninterruptible power supply

If you have connected a UPS to a USB port of the HMI device, you can display the monitoring status of this port.

Requirement

- The Control Panel is open.
- The UPS is connected to the 24-V input and to the HMI device's USB port.
- The "Uninterruptible Power Supply (UPS) with USB support" option is transferred to the HMI device with ProSave.
- UPS settings are configured

Procedure

Proceed as follows:

1. Open the "UPS Properties" dialog with the UPS icon.
2. Open the "Current status" tab.

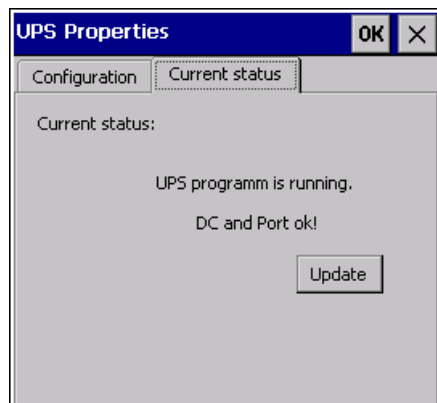

3. Refresh the monitoring status when necessary with "Update".

Result

The current monitoring state for the UPS is displayed.

See also

Setting the uninterruptible power supply (Page 106)

Reference for functions (Page 79)

4.4.9 Enabling PROFINET services

PROFINET services must be enabled on the HMI device in the following circumstances:

- The HMI device is connected to the PLC via PROFINET.
- Function keys or buttons are configured as PROFINET IO direct keys in the project.
- The backlighting of the HMI device is to be controlled with PROFlenergy.

Note

If you enable PROFINET services, you cannot use the RS 422/RS 485 port for serial operation.

PROFINET IO direct keys and PROFIBUS DP direct keys are mutually exclusive.

Rules for the device name

Within the ETHERNET data network, the device name must be unique and satisfy the DNS conventions:

- The device name may have a maximum of 127 characters.
- The following characters are allowed:
 - Letters from "a" to "z"
 - Numbers from "0" to "9"
 - Special characters "." and "-"
- A name component within the device name, for example a string between two points, may not exceed 63 characters.
- The device name must not start or end with a the "-" character.
- The device name may not take the form "n.n.n.n" (n = 0 to 999).
- The device name must not start with the character sequence "port-xyz-" (x, y, z = 0 to 9).

Requirement

The Control Panel is open.

Procedure

Proceed as follows:

1. Open the "PROFINET" dialog with the PROFINET icon.

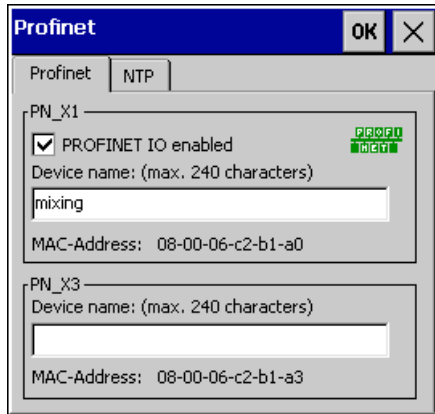

Comfort devices of 15" or more come with the second network adapter "PN_X3".

2. To enable the PROFINET services, activate "PROFINET IO enabled".

NOTICE

Inconsistent device name

If the device name does not match the device name entered in the WinCC, the direct keys will not work.

Use the device name from WinCC. The device name from WinCC is automatically adopted during transfer.

This device name is not the same as that under Windows CE.

3. If required, enter the device name of the HMI device under "Device name".
4. Confirm your entries with "OK".

Result

The PROFINET services are enabled.

Switching on disabled backlighting

If backlighting is switched off, switch it on again using PROFlenergy. Alternatively, you can reactivate backlighting on the HMI device as follows:

- Briefly touch the touch screen or press a key to set the screen brightness to full brightness.
- Touching the touch screen or pressing the "Cursor up" key for longer increases the screen brightness incrementally.

See also

Reference for functions (Page 79)

4.4.10 Synchronizing the time via the time server

Introduction

To obtain the time of the HMI device from a time server, you can specify up to four different time servers. The time is synchronized via the "Network Time Protocol" (NTP). You additionally specify the synchronization cycle for the time. The synchronization cycle applies to all configured time servers.

You can separately test the availability of each time server.

Requirement

- The Control Panel is open.
- HMI device and time servers are located in a network.

Procedure

Proceed as follows:

1. Open the "Profinet" dialog with the PROFINET IO icon.
2. Open the "NTP" tab.

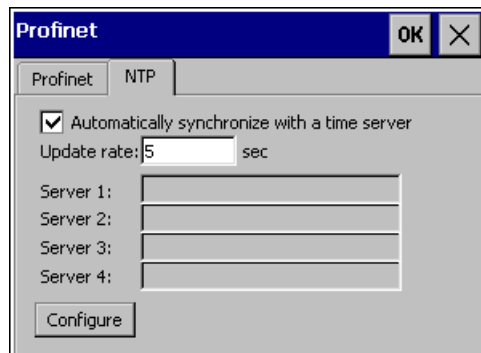

3. Select "Automatically synchronize with a time server".
4. Under "Update rate" enter the number of seconds after which HMI device synchronizes the time.

5. Press "Configure" to open the "Time Server Configuration" dialog for configuring the time servers:

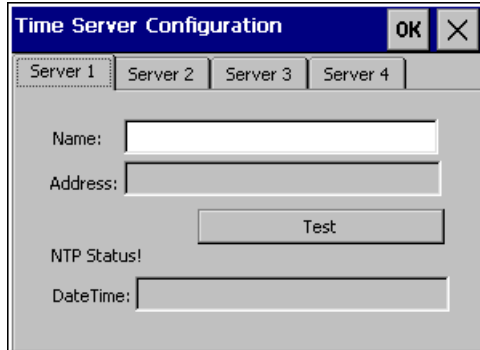

6. Enter the DNS name of the time server under "Name".
Alternatively, you can enter the IP address of time server.
7. Use "Test" to test the availability of the time server.
The connection to the time server is established and the time is displayed under "DateTime:". The IP address of the time server is also entered under "Address".
8. Up to three additional time servers can be set up as required.
9. Confirm your entries with "OK".

Result

The time servers are configured.

4.4.11 Changing transfer settings

4.4.11.1 Configuring the data channel

In the transfer settings of the HMI device, set the following:

- Releasing and locking a data channel
- Enabling and disabling automatic transfer
- Configuring data channels

If you lock the data channels, the HMI device is protected against unintentional overwriting of the project data and HMI device image. To download a project to the HMI device, the data channels must be released and configured.

Requirement

The Control Panel is open.

 WARNING
Unintentional transfer mode
Unintentional transfer mode could cause unintentional actions to be triggered in the plant.
Ensure that the configuring PC does not inadvertently switch the HMI device to transfer mode when the project is open.

Note

If the HMI device is in "Transfer" mode while changes are made to the transfer settings, the settings only go into effect after the transfer function is restarted.

This may occur if the Control Panel is opened to change the transfer properties in an active project.

Procedure

Proceed as follows:

1. Open the "Transfer Settings" dialog with the Transfer Settings icon.
2. Open the "Channel" tab.

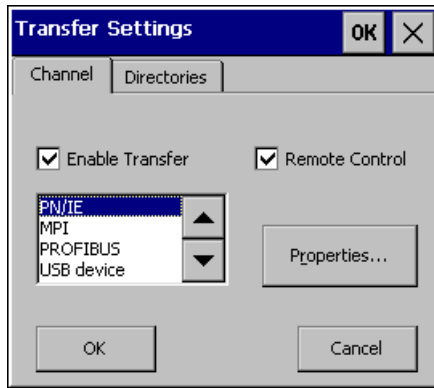

3. To release the data channels of the HMI device, select "Enable Transfer".
4. To enable automatic transfer, select "Remote Control".
5. Configure at least one data channel:
 - Select the data channel.
 - Configure the data channel using "Properties...".

Note: The "USB device" data channel has no configurable properties.
6. Confirm your entries with "OK".

Result

The data channel is configured.

See also

- Changing MPI/PROFIBUS DP settings (Page 115)
- Changing the network configuration (Page 119)
- Reference for functions (Page 79)

4.4.11.2 Changing MPI/PROFIBUS DP settings

Introduction

The communication settings for MPI or PROFIBUS DP are defined in the project of the HMI device.

In the following cases, the transfer settings might have to be changed:

- The first time the project is transferred
- If changes are made to the project but are only applied later

NOTICE

Transfer mode using MPI/PROFIBUS DP

The bus parameters are read from the project currently loaded on the HMI device.

The settings for MPI/PROFIBUS DP transfer can be modified. The following steps are required:

- Close the project.
- Change the settings on the HMI device.
- Then return to "Transfer" mode.

The changed MPI/PROFIBUS DP settings will be overwritten in the following cases:

- The project is started again
- A project is transferred and started

Transfer settings

If the HMI device is in "Transfer" mode while changes are made to the transfer settings, the settings only go into effect after the transfer function is restarted.

Requirement

- The Transfer Settings dialog is open.
- "MPI" or "PROFIBUS" is selected.

Procedure

Proceed as follows:

1. Use "Properties" to open the "MPI" or "PROFIBUS" dialog.

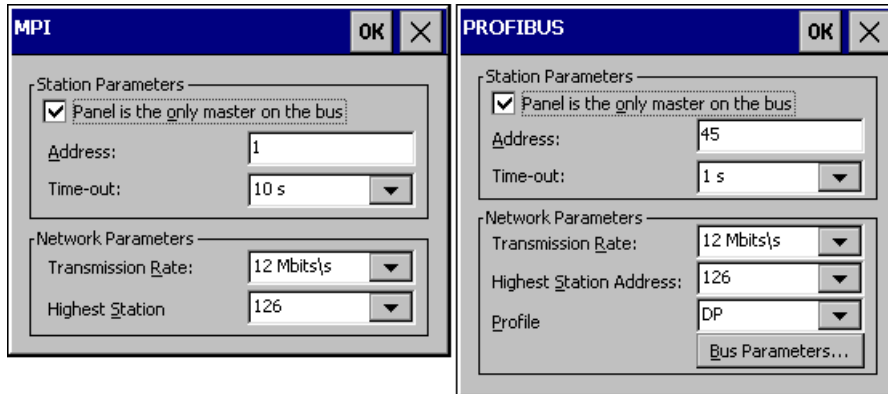

2. If there are several masters connected on the bus, deactivate the "Panel is the only master on the bus" check box.
3. Enter the bus address for the HMI device under "Address".

NOTICE
The bus address in the "Address" text box must be unique throughout the MPI/PROFIBUS DP network.

4. Select the transfer speed under "Transmission Rate".
5. Enter the highest station address on the bus under "Highest Station Address" or "Highest Station".
6. PROFIBUS only: Select the desired profile under "Profile".
Use "Bus Parameters" to view the profile data.

NOTICE
The bus parameters must be the same for all stations in the MPI/PROFIBUS DP network.

7. Confirm your entries with "OK".

Result

The MPI/PROFIBUS DP settings of the HMI device have been changed.

See also

- Configuring the data channel (Page 113)
- Reference for functions (Page 79)

4.4.12 Configuring network operation

4.4.12.1 Overview of network operation

Introduction

You can connect the HMI device to a PROFINET network via the Ethernet port.

NOTICE
The HMI device only has client functionality in the PC network. This means that users can access files of a node with TCP/IP server functionality from the HMI device via the network. However, you cannot, for example, access files of the HMI device from a PC via the network.

Note

Information on communication using SIMATIC S7 via PROFINET is provided in the online help of WinCC.

The connection to a network offers, for example, the following options:

- Printing via a network printer
- Saving, exporting and importing of recipe data records on or from a server
- Setting up of alarm and data archives
- Transferring a project
- Saving data

Addressing

Within a PROFINET network, computers are usually addressed using computer names. These device names are translated from a DNS or WINS server to TCP/IP addresses. This is why a DNS or WINS server is needed for addressing via computer names when the HMI device is in a PROFINET network.

The corresponding servers are generally available in PROFINET networks.

Note

The use of TCP/IP addresses to address PCs is not supported by the operating system.

Consult your network administrator if you have questions in this regard

Printing via a network printer

The HMI device's operating system does not support line by line alarm logging via a network printer. All other printing functions, for example, hardcopy or logs, are available without restriction via the network.

Preparation

Before beginning the configuration, request the following network parameters from your network administrator.

- Does the network use DHCP for dynamic assignment of network addresses?
If not, get a new TCP/IP network address for the HMI device.
- Which TCP/IP address does the default gateway have?
- If a DNS network is used, what are the addresses of the name server?
- If a WINS network is used, what are the addresses of the name server?

General procedure for configuring the network

The HMI device must be configured prior to network operation. The configuration is basically divided into the following steps:

Proceed as follows:

1. Enter the device name of the HMI device.
2. Configure the network address.
3. Set the logon information.
4. Save the settings.

Alternatively, you can configure the network address in the "Devices & Networks" editor in WinCC. You can find more information on this topic in the online help of WinCC.

See also

Reference for functions (Page 79)

4.4.12.2 Setting the device name of the HMI device

The HMI device uses the device name to identify itself in the communication network.

Requirement

The Control Panel is open.

Procedure

Proceed as follows:

1. Open the "System Properties" dialog with the System icon.
2. Open the "Device Name" tab.



3. Enter the computer name of the HMI device under "Device name".
The computer name must be unique within the network.
4. If necessary, enter a description for the HMI device under "Device description".
5. Confirm your entries with "OK".

Result

The computer name for the HMI device is now set. The network functionality is enabled.

See also

Reference for functions (Page 79)

4.4.12.3 Changing the network configuration

You can change the network settings for the LAN connection under "Network&Dial-Up Connections". You can also configure the properties of the Ethernet ports of the HMI device.

The transmission mode and the speed of the Ethernet ports are set automatically by default. You can also set limits for the two Ethernet ports:

- "End of detection of accessible nodes"
DCP frames for detecting available nodes are not forwarded. Nodes located beyond this Ethernet port are no longer available.
- "End of topology discovery"
LLDP frames for topology detection are not forwarded.

Note

Network settings on the KP400 Comfort and KTP400 Comfort

The HMI devices KP400 Comfort and KTP400 Comfort only have one Ethernet port.

Requirement

The Control Panel is open.

Procedure

Proceed as follows:

1. Open the network adapter display with the "Network&Dial-Up Connections" icon. The image below shows the network adapter of a KP1500 Comfort.



Comfort devices of 15" or more come with the second network adapter "PN_X3".

The interface for the HMI devices KP400 Comfort and KTP400 Comfort is called "FEC".

2. Open the "PN_X1" entry.
The "'PN_X1' Settings" dialog box opens.
3. Open the "IP Address" tab.

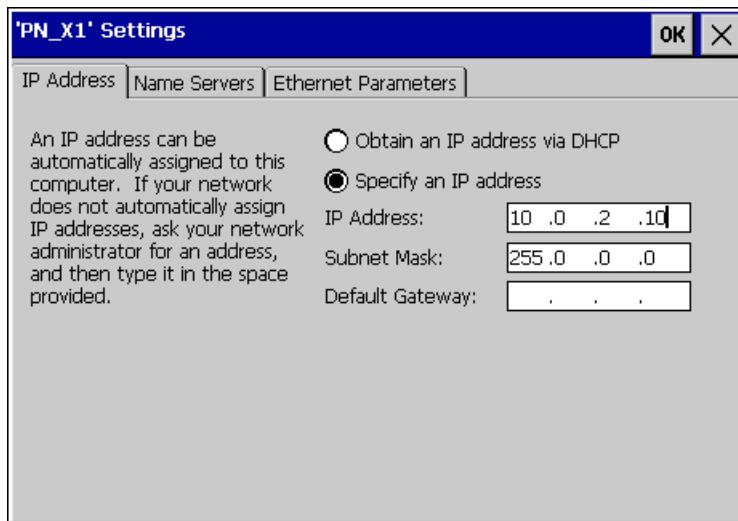

4. Select the type of address assignment:
 - To determine the address automatically, select "Obtain an IP address via DHCP".
 - To determine the address manually, select "Specify an IP address".

5. If you have selected manual address assignment, enter the corresponding addresses under "IP Address", "Subnet Mask" and if necessary under "Default Gateway".

NOTICE
PROFINET I/O error if the PN_X1 and PN_X3 subnet masks are identical
In principle, the two network adapters may be assigned to a shared physical subnetwork.
If you have enabled PROFINET services for PN_X1 and the IP subnet masks of the two network adapters are identical, PROFINET I/O errors may occur.
Assign a different entry for each network adapter in PROFINET I/O operation under "Subnet Mask".

Note

Alternatively, you can configure the network address in the "Devices & Networks" editor in WinCC. You can find more information on this topic in the online help of WinCC.

6. If a name server is used in the network, change to the "Name Servers" tab.

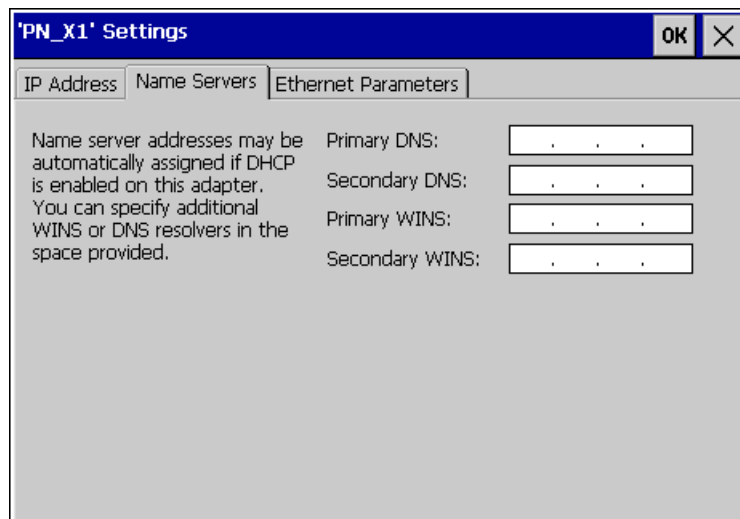

7. Enter the appropriate addresses.

8. If you want to set additional Ethernet parameters, open the "Ethernet Parameters" tab.

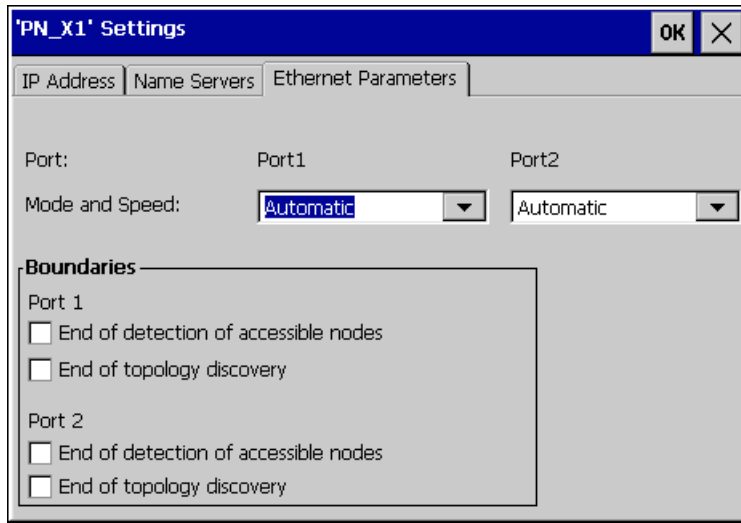

The KP400 Comfort and KTP400 Comfort HMI devices only have one Ethernet port ("Port1").

9. If needed, select the transmission mode and speed for the Ethernet port of the HMI device.
10. Change the limits for the Ethernet ports "Port 1" and "Port 2" if needed.
11. Confirm your entries with "OK".

Result

The LAN connection parameters for the HMI device have been changed.

See also

Configuring the data channel (Page 113)

Reference for functions (Page 79)

4.4.12.4 Changing the logon data

Use the Windows CE login information to gain access to network resources. You can obtain the login data "User name", "Password" and "Domain" from your administrator.

Requirement

The Control Panel is open.

Procedure

Proceed as follows:

1. Open the "Network ID" dialog with the Network ID icon.

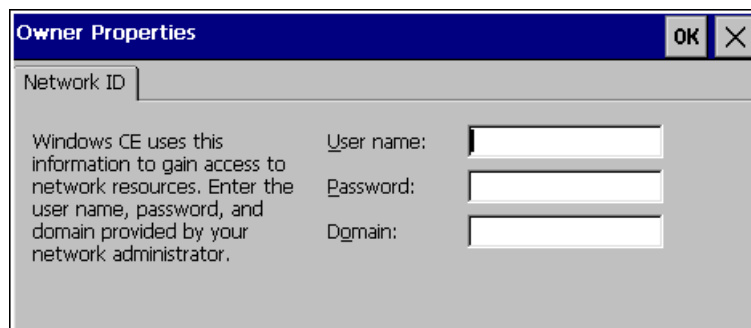

2. Enter the user name under "User name".
3. Enter your password under "Password".
4. Enter the domain name under "Domain".
5. Confirm your entries with "OK".

Result

The logon information has now been set.

See also

Reference for functions (Page 79)

4.4.12.5 Changing e-mail settings

Requirement

The Control Panel is open.

Note

Additional tabs may appear in the "WinCC Internet Settings" dialog. This depends on the options that have been enabled for network operation in the project. For more information, please refer to the WinCC or WinCC flexible Online Help.

Procedure

Proceed as follows:

1. Open the "WinCC Internet Settings" dialog with the icon of the same name.
2. Open the "Email" tab.



3. Specify the SMTP server:
 - Select "Use the default of the project file" if you want to use the SMTP server defined in the project.
 - Select the empty box and enter the desired SMTP server if you do not want to use the SMTP server configured in the project.
4. Enter information about the e-mail account:
 - Enter the name for the sender under "Sender".
 - Enter the e-mail account for sending your e-mail under "Authentication".

Some e-mail providers only allow you to send mail if you specify the e-mail account. The "Authentication" text box can remain empty if your e-mail provider allows you to send mail without checking the account.

5. Use "Advanced" to open the "Advanced Email Settings" dialog:
 - Enter the user name of the e-mail account under "Login".
 - Enter the password for the e-mail account under "Password".
6. Confirm your entries with "OK".

Result

The e-mail settings have been changed.

See also

Reference for functions (Page 79)

4.4.12.6 Configuring Telnet for remote control

If the Telnet service is enabled, you can remotely control the HMI device via Telnet.

Requirement

The Control Panel is open.

Procedure

Proceed as follows:

1. Open the "WinCC Internet Settings" dialog with the icon of the same name.
2. Open the "Telnet" tab.



3. Select the "telnet service enabled" option.
4. Confirm your entries with "OK".

Result

The Telnet service is now enabled on the HMI device. You can remotely control the HMI device via Telnet without restrictions.

See also

Reference for functions (Page 79)

4.4.13 Changing Internet settings

4.4.13.1 Changing general Internet settings

Requirement

The Control Panel is open.

Procedure

Proceed as follows:

1. Open the "Internet Options" dialog with the Internet Options icon.
2. Open the "General" tab.

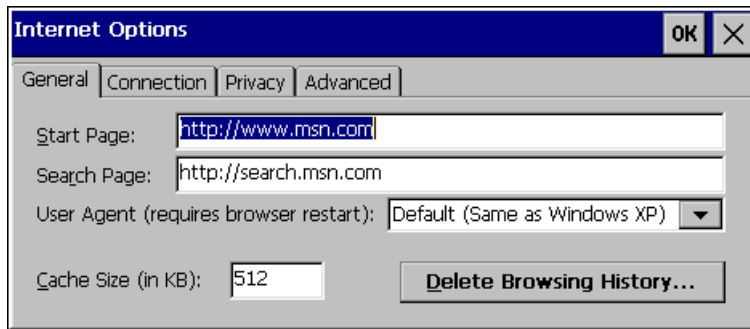

3. Enter the homepage for the Internet browser under "Start Page".
4. Enter the address of the search engine under "Search Page".

Note

Do not change the settings in the "User Agent" field.

5. Enter the desired cache memory size under "Cache Size".

6. If you want to clear the cache:
 - Open the "Delete Browsing History" dialog with the "Delete Browsing History..." button.
 - Use "Delete" or "Delete all" to delete all temporary data and the history.
 - If cookies should be deleted each time you exit your browser, select "Delete cookies on browser exit".
7. Confirm your entries with "OK".

Result

The general parameters for the Internet browser have been set.

See also

Reference for functions (Page 79)

4.4.13.2 Setting the proxy server

Requirement

The Control Panel is open.

Procedure

Proceed as follows:

1. Open the "Internet Options" dialog with the Internet Options icon.
2. Open the "Connection" tab.

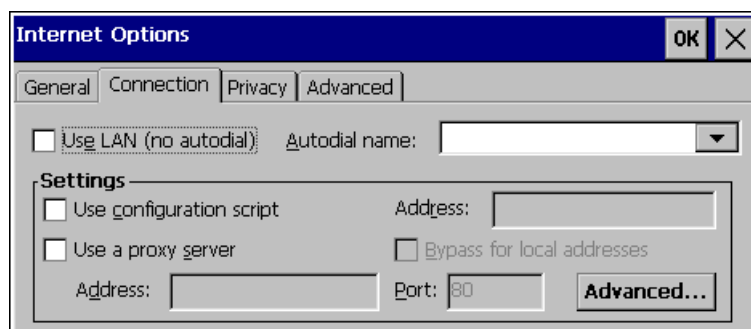

3. Select the "Use LAN (no autodial)" check box.
4. Configure the proxy server:
 - Select the "Use a proxy server" option under "Settings".
 - Specify the address of the proxy server and the port.
 - If you want to bypass the proxy server for local addresses, select "Bypass proxy server for local addresses".

5. If you want to define exceptions for specific addresses:
 - Open the "Advanced Proxy Settings" dialog with the "Advanced..." button.
 - Enter the desired addresses.
 - Separate multiple addresses with a semicolon.
6. Confirm your entries with "OK".

Result

The proxy server is configured.

See also

Reference for functions (Page 79)

4.4.13.3 Changing privacy settings

Cookies and encryption

Cookies are pieces of information sent by a web server to a browser. In the event of subsequent access to the web server, the cookies are sent back. This enables information to be stored between the accesses.

In order to ensure a high level of privacy, data are sent via the Internet in encrypted form. Common encryption protocols include SSL and TLS. You can activate or deactivate the usage of encryption protocols.

The required settings can be obtained from your network administrator.

Requirement

The Control Panel is open.

Procedure

Proceed as follows:

1. Open the "Internet Options" dialog with the "Internet Options" icon.
2. Open the "Privacy" tab.

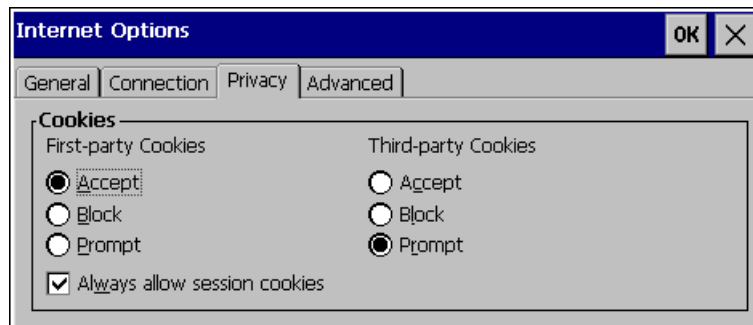

3. Select the behavior for handling cookies.
 - "Accept"
Cookies are stored without request.
 - "Block"
Cookies will not be stored.
 - "Prompt"
Cookies will be stored on request.
4. If you want to allow cookies which are restricted to a single session, select "Always allow session cookies".
5. Open the "Advanced" tab.

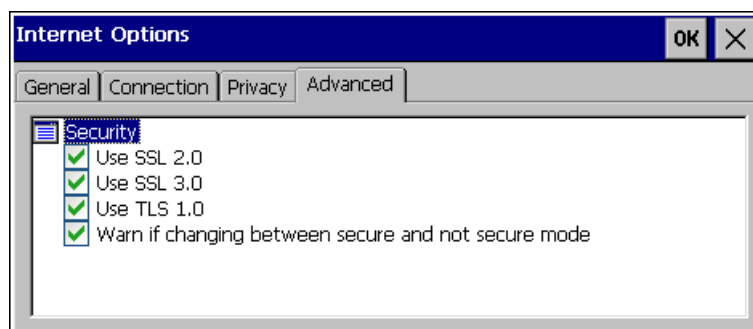

6. Activate the required encryption protocol.
7. Confirm your entries with "OK".

Result

The logon information has now been set.

See also

Reference for functions (Page 79)

4.4.13.4 Importing and deleting certificates

You can import, view and delete certificates that have been imported for the HMI device. The certificates differ in the following ways:

- Certificates that you trust
- Own certificates
- Other certificates

You can import additional certificates and delete certificates that are not required.

The required settings can be obtained from your network administrator.

Requirement

The Control Panel is open.

Procedure

Proceed as follows:

1. Open the "Certificates" dialog with the Certificates icon.



2. Select the type of certificate from the selection box:
 - "Trusted Authorities"
 - "My Certificates"
 - "Other Certificates"
3. If you want to import a certificate:
 - Start the import with the "Import" button.
The "Import Certificate or Key" dialog box opens.
 - Select the data source and confirm it with "OK".
The file selection dialog opens.
 - Navigate to the location of the certificate and select the certificate.
 - Confirm with "OK".

The certificate is imported to the certificate storage area of the HMI device.

4. If you want to display information about a certificate:
 - Select the certificate.
 - Display the information with the "View" button.
5. If you want to delete a certificate:
 - Select the certificate.
 - Delete the certificate with the "Remove" button.

The certificate is deleted from the certificate storage area of the HMI device.
6. Confirm your entries with "OK".

The dialog closes.

Result

The changes to the certificates have been performed.

See also

Reference for functions (Page 79)

4.4.14 Saving to external storage device (backup)

Introduction

You can backup the operating system, applications and data from the internal memory of the HMI device to an external storage medium.

The following external storage media can be used:

- Memory card
- USB storage medium, e.g. USB stick

Requirement

- External storage medium with sufficient free capacity is inserted in the HMI device.
- External storage medium is formatted.
- The Control Panel is open.

Procedure

Proceed as follows:

1. Open the "Backup/Restore" dialog with the "Backup/Restore" icon.

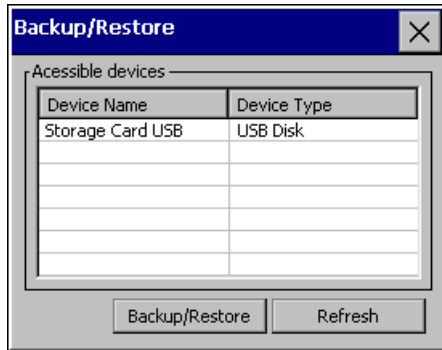

The available external storage media are shown in the list.

2. Select the desired external storage medium and press "Backup/Restore".
3. Open the "Backup/Restore" dialog in the "Backup" tab.



The backup files on the external storage media are shown in the list.

4. Select a blank entry and start the backup process using "Backup".

The external storage medium is tested. The progress of the back process is then displayed under "Current Step". The end of the backup process is displayed with the alarm "The operation completed successfully".

5. Acknowledge this alarm.

The dialog closes.

Result

The data from the HMI device is saved in a backup file on the external storage medium.

See also

Reference for functions (Page 79)

4.4.15 Restoring from external storage device

Introduction

A restore operation deletes the internal memory of the HMI device upon confirmation. The content of the backup file is then copied from the external storage medium into the internal memory of the HMI device. The HMI device is then restarted.

The following external storage media can be used:

- Memory card
- USB storage medium, for example USB stick

Requirement

- The external memory with the backup file is inserted in the HMI device.
- The Control Panel is open.

NOTICE

Loss of data possible

All data on the HMI device will be deleted during a restore operation. License keys are deleted after counter-inquiry.

Back up the HMI device's data before restoring if required.

Procedure

Proceed as follows:

1. Open the "Backup/Restore" dialog with the Backup/Restore icon.

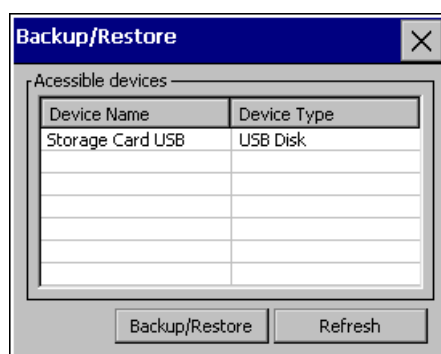

The available external storage media are shown in the list.

2. Select the desired external storage medium and press "Backup/Restore".

3. Open the "Restore" tab in the "Backup/Restore" dialog.

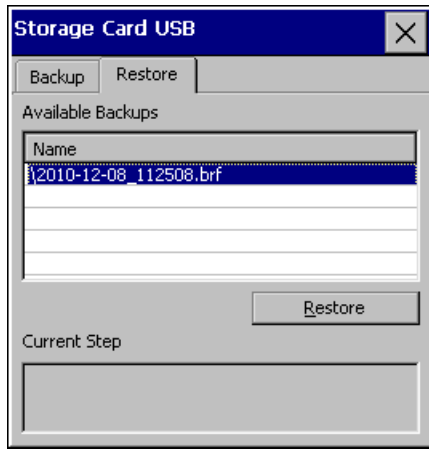

The backup files on the selected storage medium are shown in the list.

4. Select a backup file and start the restore process using the "Restore" button.

The content of the backup file is checked. After a successful test, the alarm is displayed stating that the data from the internal memory have been deleted.

5. Acknowledge this alarm.

The internal memory is deleted. The content of the backup file is then copied into the internal memory. A progress bar shows the status of the restore process. After successful restoration, you are prompted to remove the external storage medium and restart the HMI device.

6. Remove the external memory.

7. Acknowledge this alarm.

The HMI device starts.

Result

The data from the backup file are restored in internal memory of the HMI device.

Note

Calibrating the touch screen

After the restore, you may have to recalibrate the touch screen.

See also

Reference for functions (Page 79)

4.4.16 Activate memory management

NOTICE

Memory management

If you do not activate memory management, undefined states can occur during the runtime of the project.

Requirement

The Control Panel is open.

Procedure

Proceed as follows:

1. Open the "OP Properties" dialog with the OP icon.
2. Open the "Memory Monitoring" tab.

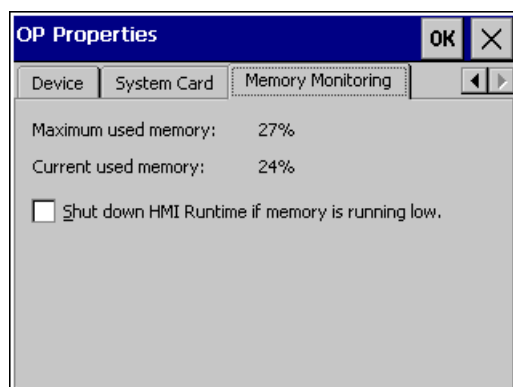

3. If you want to enable memory management, select "Shut down HMI Runtime...".
4. Confirm the entry with "OK".

Result

Memory management is activated. An open project is closed in these circumstances:

- Insufficient RAM
- RAM needs to be reorganized

An alarm is then triggered on the HMI device. Restart the project on the HMI device.

See also

Reference for functions (Page 79)

Commissioning a project

5.1 Overview

Configuration phase

A project – the process image of the working process – is produced during configuration to visualize automated working processes. The process displays for the project contain displays for values and alarms which provide information about process statuses. The process control phase follows the configuration phase.

Process control phase

The project must be transferred to the HMI device if it is to be used in process control. Another precondition for process control is that the HMI device is connected online to a controller. Current working processes - operating and observing - can then be subject to process control.

Transferring the project to the HMI device

You can transfer a project to an HMI device as follows:

- Transfer from the configuring PC
- Restore from a PC using ProSave

In this case, an archived project is transferred from a PC to the HMI device. The configuration software need not be installed on this PC.

- Insert a prepared system memory card from an identical HMI device
Additional information is available in "Enabling the service concept (Page 62)".
- Recovery from an external storage medium from an identical HMI device (Restore)

Commissioning and recommissioning

Initial and re-start-ups differ in the following respects:

- When the HMI device is commissioned there is no project at first.
The HMI device is also in this state after the operating system has been updated.
- When recommissioning, any project already on the HMI device is replaced.

5.2 Operating modes

Operating modes

The HMI device may be in the following operating modes:

- Offline
- Online
- Transfer

Changing the operating mode

The configuration engineer must have configured an appropriate operating element to allow a change of the operating mode on the HMI device during ongoing operation.

Further information on this may be available in your plant documentation

"Offline" operating mode

In this mode, there is no communication between the HMI device and PLC. Although the HMI device can be operated, it cannot exchange data with the PLC.

"Online" operating mode

In this mode, the HMI device and PLC communicate. You can operate the plant on the HMI device according to your system configuration.

"Transfer" mode

In this mode, you can transfer a project from the configuring PC to the HMI device or backup and restore HMI device data, for example.

The following options are available for setting "Transfer" mode on the HMI device:

- When the HMI device starts up

Start "Transfer" mode manually in the HMI device Loader.

- During ongoing operation

Start the "Transfer" mode manually within the project using an operating element. The HMI device toggles to "Transfer" mode when automatic mode is set and a transfer is initiated on the configuring PC.

5.3 Using existing projects

To use an existing WinCC flexible project in WinCC, migrate the project to WinCC.

You can find more information on this topic in the online help of WinCC.

5.4 Data transmission options

Overview

The following table shows the options for data transfer between an HMI device and the configuring PC.

Type	Data channel	HMI device
Backup	MPI/PROFIBUS DP	Yes
	USB	Yes
	PROFINET ¹	Yes
	Ethernet	Yes
Restoring	MPI/PROFIBUS DP	Yes
	USB	Yes
	PROFINET ¹	Yes
	Ethernet	Yes
Updating the operating system	MPI/PROFIBUS DP	Yes
	USB	Yes
	PROFINET ¹	Yes
	PROFINET, with reset to factory settings ¹	Yes
	Ethernet	Yes
Transferring a project	MPI/PROFIBUS DP	Yes
	USB	Yes
	PROFINET ¹	Yes
	Ethernet	Yes
Installing or removing an add-on	MPI/PROFIBUS DP	Yes
	USB	Yes
	PROFINET ¹	Yes
	Ethernet	Yes
License key transferring or transferring back	MPI/PROFIBUS DP	Yes
	USB	Yes
	PROFINET ¹	Yes
	Ethernet	Yes

¹ Select "PN/IE" as the access point

5.5 Transfer

5.5.1 Setting transfer mode

Introduction

You can start the "Transfer" mode manually or automatically on the HMI device.

If the automatic transfer is enabled, the HMI device automatically switches to "Transfer" mode when the following event occurs during runtime: You start project transfer on the connected configuring PC.

Note

With automatic transfer, the HMI device only switches to "Transfer" mode when the project is running on the HMI device.

Automatic transfer is particularly suited for the test phase of a new project since transfer is completed without interfering with the HMI device.

NOTICE
<p>If automatic transfer is activated on the HMI device and a transfer is initiated on the configuring PC, the project currently running is automatically stopped. The HMI device then automatically switches to "Transfer" mode.</p> <p>After the commissioning phase, deactivate the automatic transfer so that the HMI device cannot be inadvertently switched to transfer mode. The transfer mode can trigger unintentional reactions in the plant.</p> <p>You can issue a password in the Control Panel to restrict access to the transfer settings and thus avoid unauthorized modifications.</p>

Requirement

- The Control Panel is open.
- The Runtime software is terminated.

Procedure

Proceed as follows:

1. Open the "Transfer Settings" dialog with the Transfer Settings icon.
2. Open the "Channel" tab.

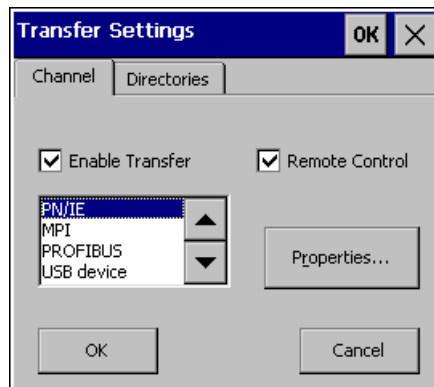

3. Select "Enable Transfer".
4. Select the data channel and set its parameters using "Properties...".
Exception: The "USB device" data channel has no parameters.
5. To start "Transfer" mode automatically:
 - Select "Remote Control".
 - Close the dialog with "OK".
6. To start "Transfer" mode manually:
 - Disable "Remote Control".
 - Close the dialog with "OK".
 - Close the Control Panel.
 - Enable transfer mode in the loader with "Transfer".

Result

"Transfer" mode is set. The project is transferred from the configuration PC via the data channel selected on the HMI device. If required, configure the corresponding data channel on the configuration PC.

Transferred data is written directly to internal memory of the HMI device.

Alternative procedure

Alternatively, you can also set "Transfer" mode on the HMI device using an operating element in the project. To do this, configure the "SetDeviceMode" system function on an operating element event, for example, on a button.

You can find more information on this topic in the online help of WinCC.

See also

Configuring the data channel (Page 113)

5.5.2 Start transfer

Introduction

To make a project executable on an HMI device, transfer the project from the configuring PC to the HMI device. With a transfer, you particularly specify whether to overwrite existing data on the HMI device such as the "User management" or "Recipe data".

Requirement

- The project is opened in WinCC on the configuration PC.
- Project tree is displayed.
- Configuring PC is connected to the HMI device.
- Transfer mode is set on the HMI device.

Procedure

Proceed as follows:

1. Select the "Download to device > Software" command in shortcut menu of the HMI device.
2. When the "Extended download to device" dialog opens, configure the "Transfer settings". Ensure here that the "Transfer settings" match the "Transfer settings on the HMI device":
 - Select the protocol used, for example, Ethernet or USB.
If you are using Ethernet or PROFINET, you can also configure the network address in the "Devices & Networks" editor in WinCC. You can find more information on this topic in the online help of WinCC.
 - Configure the appropriate interface parameters on the configuring PC.
 - Make the specific interface or protocol settings on the HMI device as required.
 - Click "Download".

You can open the "Extended download to device" dialog at any time using the menu command "Online > Extended download to device...".

The "Load preview" dialog opens. The project is compiled at the same time. The result appears in the "Load preview" dialog.

3. Check the displayed default settings and change them if necessary.
4. Click "Download".

Result

The project is transferred to the selected HMI device. If errors or warnings occur during the transfer, appropriate alarms are displayed in the Inspector window under "Info> Download".

When the transfer is completed successfully, the project is executable on the HMI device.

5.5.3 Testing a project

Introduction

There are two options to test a project:

- Test the project on the configuring PC

You can test a project at a configuring PC, using a simulator. You can find more detailed information on this in the online help of WinCC.

- Offline testing of the project on the HMI device

Offline testing means that communication between the HMI device and PLC is down while the test is being carried out.

- Online testing of the project on the HMI device

Online testing means that the HMI device and PLC communicate with each other during testing.

Perform the tests, starting with the "Offline test", followed by the "Online test".

Note

You should always test the project on the HMI device on which the project will be used.

Check the following:

1. Check the correct layout of the screens
2. Check the screen navigation
3. Check the input objects
4. Enter the tag values

The test increases the certainty that the project will run error-free on the HMI device.

Requirement for offline testing

- The project has been transferred to the HMI device.
- The HMI device is in "Offline" mode.

Procedure

In "Offline" mode, you can test individual project functions on the HMI device without them being affected by the PLC. PLC tags, therefore, are not updated.

Test the operating elements and visualization of the project as far as possible without connecting to the PLC.

Requirement for online testing

- The project has been transferred to the HMI device.
- The HMI device is in "Online" mode.

Procedure

In "Online" mode, you can test individual project functions on the HMI device without them being affected by the PLC. PLC tags are updated in this case.

You have the option to test all communication-dependent functions, for example alarms, etc.

Test the operating elements and views of the project.

5.6 Backup and restore

5.6.1 Overview

Backup and restore

A data backup saves the contents of the internal memory. Alarm logs and process value logs are always stored on the external storage medium. Alarm logs and process value logs are not backed up. Manually back up the contents of the memory card if required. If the HMI device is integrated in a network, you can also back up the data on a network drive.

The following data are backed up:

- Project and HMI device image
- User administration
- Recipe data
- License keys

Use WinCC for backup and restore.

General information

NOTICE
Power failure If a complete restore operation is interrupted due to power failure on the HMI device, the operating system of the HMI device may be deleted. In this case, you have to reset the HMI device to its factory settings. The HMI device automatically switches to "bootstrapping" mode.
Compatibility conflict If a alarm is output on the HMI device warning of a compatibility conflict during the restore operation, the operating system must be updated.

See also

Saving to external storage device (backup) (Page 131)

5.6.2 Backing up and restoring data of the HMI device

Note

Only use the restore function for project data on HMI devices that were configured with the same configuration software.

Requirement

- The HMI device is connected to the configuring PC.
- The HMI device is selected in the project tree.
- If a server is used for data backup: The configuring PC has access to the server.

Backing up data of the HMI device

To back up the data of the HMI device, follow these steps:

1. Select the "Backup" command in the "Online > HMI device maintenance" menu.
The "SIMATIC ProSave" dialog opens.
2. Under "Data type", select which data of the HMI device should be saved.
3. Under "Save as", enter the name of the backup file.
4. Click "Start Backup".

This starts the data backup. The backup process can take time, depending on the connection selected.

Restoring data of the HMI device

To restore the data of the HMI device, follow these steps:

1. Select the "Restore" command in the "Online > HMI device maintenance" menu.
2. Under "Opening...", enter the name of the backup file.
Information about the selected backup file is displayed under "Content".
3. Click "Start Restore".

This starts the restoration. This process can take time, depending on the connection selected.

Backup / Restore via the "Backup/Restore" dialog in the Control Panel of the HMI device

The "Backup / Restore" function is approved for MMC and SD memory cards, as well as USB mass storage devices.

See also

Saving to external storage device (backup) (Page 131)

Restoring from external storage device (Page 133)

5.7 Updating the operating system

5.7.1 Updating the operating system

Introduction

If the operating system version of an HMI device is not compatible with the configuration, you need to update the operating system of the HMI device. Depending on the protocol used, the operating system on the HMI device is updated automatically upon prompting when the project is loaded. Thereafter, the loading continues. Otherwise, the loading of the project is canceled. In this case, you have to start the update of the operating system manually.

Updating the operating system

To update the operating system of an HMI device, connect the HMI device to the configuring PC. If possible, use the interface with the highest bandwidth, for example, Ethernet, to make this connection.

"Reset to factory settings"

If the operating system on the HMI device is no longer functional, update your operating system and restore the factory settings on the HMI device. If the HMI device detects the fault itself, the HMI device automatically restarts in "bootstrapping" mode and issues an appropriate message.

5.7.2 Updating the operating system of the HMI device

If possible, use the interface with the highest bandwidth, for example, Ethernet, to make the connection.

CAUTION

Updating the operating system deletes all data on the HMI device

If you update the operating system, data on the target system is deleted. Therefore, first back up the following data:

- User administration
- Recipes

A reset to the factory settings also deletes the license keys. Back up the license keys as well before restoring the factory settings.

Note

Calibrating the touch screen

After the update, you may have to recalibrate the touch screen.

Requirement

- The HMI device is connected to the configuring PC.
- The PG/PC interface is set
- The HMI device is selected in the project tree.
- The HMI device is switched on.

Updating the operating system

The configuration settings from "Devices & Networks" are used to establish a connection between the HMI device and the configuration PC.

To update the operating system, follow these steps:

1. Select the "Update operating system" command in the "Online > HMI device maintenance" menu.

The "SIMATIC ProSave [OS-Update]" dialog box opens. The path to the image of the operating system is already set.

2. If needed, select another path for the operating system image that you wish to transfer to the HMI device.
3. Click "Update OS".

This starts the update. The update operation can take time, depending on the connection selected.

The HMI device is reset to the factory settings.

To restore the factory settings on the HMI device, follow these steps:

1. Set the HMI device to "bootstrapping" mode.

- Open the "OP Properties" dialog on the HMI device in the Control Panel.
- Switch to the "Device" tab and select "Reboot".

The "Attention" dialog box opens.

- Select "Prepare for Reset".

The HMI device restarts and switches to "bootstrapping" mode. If you do not reset the HMI device to the factory settings, the HMI device restarts after 10 minutes.

2. Select the "Update operating system" command in the "Online > HMI device maintenance" menu on the configuring PC in WinCC.

The "SIMATIC ProSave [OS-Update]" dialog box opens. The path to the image of the operating system is already set.

3. If needed, select another path for the operating system image that you wish to transfer to the HMI device.
4. Enable "Reset to factory settings".
5. Enter the MAC address of the HMI device.
6. Click "Update OS".

The operation can take some time.

Result

The operating system of the HMI device is now operational and updated to the latest version.

5.8 Managing add-ons and license keys

5.8.1 Managing add-ons

Introduction

You can install the following add-ons on an HMI device:

- Add-ons supplied with WinCC
- Add-ons purchased separately from WinCC

The HMI device type determines which add-ons can be installed.

For an overview of available add-ons, refer to "Introduction to WinCC".

Requirement

- The HMI device is connected to the configuring PC.
- The PG/PC interface is set
- The HMI device is selected in the project tree.
- The HMI device is switched on.

Procedure

To install an add-on on the HMI device, follow these steps:

1. Select the "Options" command in the "Online > HMI device maintenance" menu.
All available add-ons and those already installed are shown.
2. You may also click "Device status" to display the add-ons installed on the HMI device.
3. To install an add-on on the HMI device, select the add-on and use ">>" to transfer it to the list of installed add-ons.
4. Click "<<" to remove an add-on from the HMI device.
5. To start the installation or removal, click "OK".

Result

The selected add-ons have been installed on the HMI device or removed from the HMI device.

See also

Transferring license keys (Page 150)

5.8.2 Transferring license keys

Introduction

You need a license key for WinCC Runtime add-ons to use them on an HMI device. The required licenses are usually supplied as license keys on a data medium, for example, a USB stick. You can also obtain the license keys from a license server.

Use the "Automation License Manager" to transfer the license keys to or from an HMI device. The "Automation License Manager" is installed automatically with WinCC.

CAUTION
Backing up license keys
To prevent the deletion of the license keys, you need to back them up in the following situation:
<ul style="list-style-type: none">• Prior to restoring a complete database from the backup copy

See also

Managing add-ons (Page 149)

5.8.3 Managing license keys

Requirement

- The HMI device is connected to the configuring PC or to the PC with the "Automation License Manager".
- If you use the configuring PC: The HMI device is selected in the project tree.

Procedure

To transfer the license keys, follow these steps:

1. Open the "Automation License Manager". On a PC without a WinCC installation, open the "Automation License Manager" from the Windows Start menu.
The "Automation License Manager" starts.
2. Select the "Connect HMI device" command in the "Edit > Connect Target System" menu.
The "Connect target system" dialog opens.
3. Select the "device type" of your HMI device.
4. Select the "connection".

5. Configure the corresponding "connection parameters", depending on the selected connection.

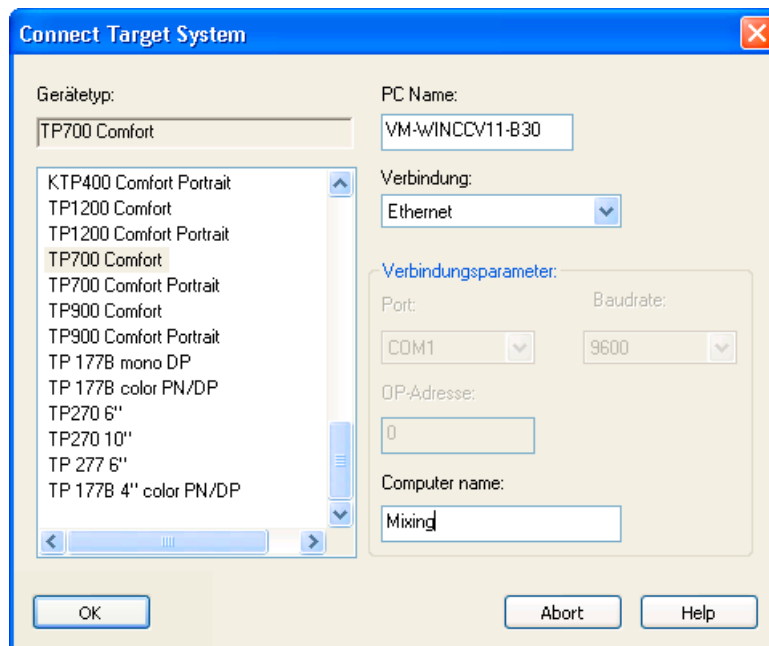

6. Click "OK".

The connection to the HMI device is established. The connected HMI device is displayed in the left area of the "Automation License Manager".

7. Transfer the license keys to the HMI device:

- In the left area, select the drive on which the license keys are located.
The license keys are shown in the right area.
- Select the license keys
- Drag-and-drop the license keys to the HMI device.

You can also remove license keys from the HMI device by means of drag-and-drop.

Alternative procedure

On a PC with a WinCC installation, you can also launch the "Automation License Manager" from WinCC: Select the "Authorize/License" command in the "Online > HMI device maintenance" menu.

Result

The license keys are transferred to the HMI device.

To back up the license keys on the HMI device, drag them from the HMI device to an available drive.

Operating a project

6.1 Overview

Operator input options

The hardware of the HMI device determines which of the following operator control options are available:

- Touch screen

The operating elements shown in the dialogs are touch-sensitive. Touch objects are basically operated in the same way as mechanical keys. You activate operating elements by touching them with your finger. To double-click them, touch an operating element twice in succession.

- HMI device keyboard

The operating elements shown in the screens are selected and operated using the keys of the HMI device.

- External keyboard, connected via USB
- External mouse, connected via USB



Do not use pointed or sharp objects to operate the touch screen. Otherwise, you can damage the plastic membrane of the touch screen.

The following provides instructions for operating a project with the touch screen and the keyboard.

Operating a project with an external keyboard

An external keyboard can be used to operate a project in exactly the same way as with the HMI keyboard or screen keyboard.

Note

The function keys of the external keyboard are disabled.

Operating a project with an external mouse

The project can be operated with an external mouse in exactly the same way as with the HMI touch screen. Click the described operating elements with the mouse.

Unintentional actions

 CAUTION
<p>Do not carry out several operations simultaneously. You may otherwise trigger unintentional actions.</p> <ul style="list-style-type: none">• With touch control: Always touch only one operating element on the screen• With key control: Do not press more than two function keys simultaneously. Exception: The keyboard shortcut <CTRL+ALT+DEL> can also be used with the system keys. Note that the "Lock Task Switching" option can be activated in the project in the Runtime settings of the HMI device.

Observing the plant documentation

Some operations with the project may require in-depth knowledge about the specific plant on the part of the operator. If you use jog mode, for example, proceed with care. Refer to your plant documentation to find any additional information on this topic.

Operation feedback from operating elements

The HMI device provides operation feedback as soon as it detects that an operating element has been selected. This operation feedback is independent of any communication with the PLC. Therefore, this operation feedback does not indicate whether the relevant action is actually executed or not.

Optical feedback from operating elements

The operating element receives the focus and is selected. The configuration engineer can also configure the selection of an operating element so that it deviates from the standard. Refer to your plant documentation to find any additional information on this topic.

The type of optical feedback depends on the operating element:

- Buttons

The HMI device generates different views for the "Pressed" and "Unpressed" states, provided the configuration engineer has configured a 3D effect:

- "Pressed" state:

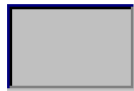

- "Unpressed" state:



The configuration engineer determines the appearance of a selected field, for example, line width and color for the focus.

- Invisible buttons

By default, invisible buttons are not displayed as pressed when they are touched. No optical operation feedback is provided in this case.

The configuration engineer may, however, configure invisible buttons so that their outline appears as lines when touched. This outline remains visible until you enable another operating element.

- I/O fields

When you select an I/O field, the content of the I/O field is displayed against a colored background. With touch operation, a screen keyboard opens for the entering of values.

Acoustic feedback from operating elements

An acoustic signal is generated as soon as the HMI device detects that the touch screen has been touched or a key has been pressed, . You can activate or deactivate this acoustic operation feedback.

Note

The acoustic feedback is only possible if you interact with the project directly on the touch screen or press one of the keys of the HMI device. If you use an external mouse or keyboard for interaction, no acoustic signal is issued.

Acoustic feedback does not mean that the action has been performed.

Acoustic signal for inadvertent operations

If you try to enter an invalid character, the HMI device issues an acoustic signal in accordance with the setting.

6.2 Function keys

Function keys

Function key assignment is defined during configuration. The configuration engineer can assign function keys globally and locally.

Function keys are available only on key HMI devices.

Function keys with global function assignment

A globally assigned function key always triggers the same action on the HMI device or in the PLC irrespective of the screen displayed. Such an action could be, for example, the activation of a screen or the closure of an alarm window.

Function keys with local function assignment

A function key with local function assignment is screen-specific and is therefore only effective within the active screen.

The function assigned locally to a function key can vary from screen to screen.

The function key of a screen can be assigned one function only, either a global or local one. The local assignment function takes priority over the global setting.

The configuration engineer can assign function keys in such a way that you can manipulate operating elements with function keys, for example, the alarm view, trend view, recipe view or status/force.

6.3 Direct keys

Introduction

Direct keys on the HMI device are used to set bits in the I/O area of a SIMATIC S7.

Direct keys enable operations with short reaction times that are, for example, a jog mode requirement.

NOTICE

Direct keys are still active when the HMI device is in "offline" mode.
--

NOTICE

If you operate a function key with direct key functionality in a running project, the direct key function is always executed, independent of the current screen contents.

Note

You can only use direct keys when there is a connection via PROFIBUS DP or PROFINET IO.

Direct keys result in additional basic load on the HMI device.

Direct keys

The following objects can be configured as a direct key:

- Buttons
- Function keys

You can also define image numbers in the case of HMI devices with touch operation. In this way, the configuration engineer can configure the direct keys on an image-specific basis.

You can find detailed information on configuring direct keys in the online help for WinCC under "Visualizing processes > Communicating with controllers".

6.4 Setting the project language

Introduction

The HMI device supports multilingual projects. You must have configured a corresponding operating element which lets you change the language setting on the HMI device during runtime.

The project always starts with the language set in the previous session.

Requirements

- The required language for the project must be available on the HMI device.
- The language switching function must be logically linked to a configured operating element such as a button.

Selecting a language

You can change project languages at any time. Language-specific objects are immediately output to the screen in the new language when you switch languages.

The following options are available for switching the language:

- A configured operating element switches from one language to the next in a list
- A configured operating element directly sets the desired language

Further information on this may be available in your plant documentation

6.5 Input of values

If you select an I/O field in the project using the tab sequence or by touch, the entire field content is selected. The screen keyboard appears on a touch HMI device.

Procedure

Proceed as follows:

1. To overwrite the value:
 - Enter the new value using the system keys or the screen keyboard.
2. To change the value:
 - Key HMI device: Deselect the content with <SHIFT+Right>.
 - Touch HMI device: Deselect the content with any cursor key.
 - Move the cursor to the desired location and change the value.
3. Close the value entry.

Result

The value of the I/O field is set.

See also

Entering and editing numeric values (Page 159)

Entering or changing alphanumeric values (Page 160)

Entering values with system keys (Page 73)

Using the screen keyboard (Page 75)

Reference for system keys (Page 69)

6.6 Entering and editing numeric values

Introduction

You enter numeric values depending on a type of HMI device, either with the system keys or the screen keyboard. Alternatively, you can also connect an external keyboard.

Note

When the screen keyboard is open, PLC job 51, "Select screen" has no function.

- With key HMI devices, only the numbers on the system keys are available.
- With touch HMI devices, a numerical screen keyboard opens.

Date and time

Date and time are entered in the same way as numeric values.

Note

When entering the date and time, note that their format is determined by the configured project language.

Entering hexadecimal values

If the configuration engineer has configured the I/O field as "Hexadecimal display", the letters "A" to "F" are available in addition to the numbers.

With touch devices, the alphanumeric screen keyboard appears in this case. The keys "G" to "Z" are not used. When you press the keys, a beep is emitted.

Limit test of numeric values

Tags can be assigned limits. If you enter a value outside these limits it will not be accepted, for example "80" is rejected if the configured limit is "78". When an alarm window is configured, a system alarm is generated on the HMI device. Regardless of this, the original value is displayed again.

Decimal places for numeric values

The configuration engineer can specify the number of decimal places for a numerical text box. The number of decimal places is checked when you enter a value in this type of I/O field.

- Decimal places in excess of the limit are ignored.
- Empty decimal places are filled with "0".

Requirement

Cursor is in an I/O field.

Procedure

Proceed as follows:

1. Enter the desired value using the system keys or the screen keyboard.
2. Discard the entry with <ESC>, if necessary.
3. Conclude your entry with <ENTER>.

Result

The numeric value has been changed. If you have discarded the entry, the I/O field remains empty or the original value is displayed.

See also

Input of values (Page 158)

Entering values with system keys (Page 73)

Using the screen keyboard (Page 75)

Reference for system keys (Page 69)

6.7 Entering or changing alphanumeric values

Introduction

Depending on the type of HMI device, you enter alphanumeric values either with the system keys or the screen keyboard. Alternatively, you can also connect an external keyboard.

Note

When the screen keyboard is open, PLC job 51, "Select screen" has no function.

- With key HMI devices, all characters on the system keys are available.
- With touch HMI devices, an alphanumeric screen keyboard opens.

Note

The screen keyboard display is independent of the configured project language.

Requirement

Cursor is in an I/O field.

Procedure

Proceed as follows:

1. Enter the desired value using the system keys or the screen keyboard.
2. Discard the entry with <ESC>, if necessary.
3. Conclude your entry with <ENTER>.

Result

The alphanumeric value has been entered or changed. If you have discarded the entry, the I/O field remains empty or the original value is displayed.

See also

Input of values (Page 158)

Entering values with system keys (Page 73)

Using the screen keyboard (Page 75)

Reference for system keys (Page 69)

6.8 Displaying infotext

Purpose

The configuration engineer uses infotext to provide additional information and operating instructions. The configuration engineer can configure infotext on screens and operating elements.

The infotext of an I/O field may contain, for example, information on the value to be entered.

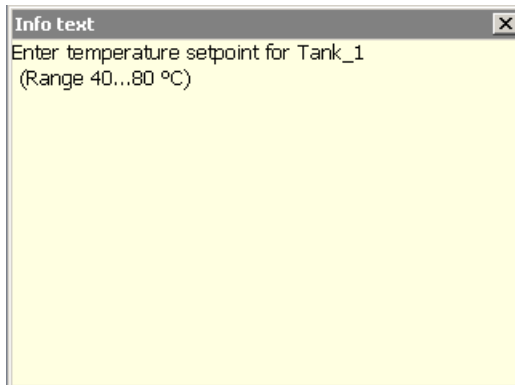

If infotext is configured for an operating element, it is displayed on the HMI device:

- With touch devices, the <Help> key is shown in the screen keyboard.
- With key HMI devices, the LED lights the <HELP> key.

Requirement

Operating element with the configured infotext is selected.

Procedure

Proceed as follows:

1. Press the <HELP> key.
The infotext for the operating element is displayed.
2. Use the cursor keys to scroll as needed.

Note

Switching between displayed infotext

The configuration engineer can configure infotext for an I/O field and the associated screen. You can switch between two infotexts by touching the infotext window.

3. Close the window with the infotext.

Alternative procedure

Depending on your configuration, infotext can also be called via a configured operating element.

Refer to your plant documentation to find any additional information on this topic.

6.9 Closing the project

Procedure

Proceed as follows:

1. Use the corresponding operating element object to close the project.
Wait for the Loader to open after you closed the project.
2. Switch off power to the HMI device.

Maintenance and care

7.1 Maintaining and caring for the touch screen and keyboard overlay

Introduction

The HMI device is designed for maintenance-free operation. The touch screen and keyboard overlay should nevertheless be cleaned regularly.

Requirement

- Damp cleaning cloth
- Washing up liquid or foaming screen cleaning agent

Procedure

NOTICE**Unintentional response**

If you clean the touch screen or an HMI device with a keyboard overlay when it is switched on, you may cause maloperations.

Switch off the HMI device or, during ongoing operation, clean the touch screen only when it is in a locked state. Note that the touch screen lock automatically ends after 15 seconds.

Damage caused by unauthorized cleaning products

Using compressed air or steam cleaners, or aggressive solutions or scouring agents will damage the HMI device.

Do not clean the HMI device with compressed air or steam jet blowers. Do not use aggressive solvents or scouring powder.

Proceed as follows:

1. Switch off the HMI device or lock the touch screen.
2. Spray the cleaning solution onto a cleaning cloth.
Do not spray directly onto the HMI device.
3. Clean the HMI device.
When cleaning the display wipe from the screen edge inwards.

7.2 Clean screen for Touch HMI devices

The touch screen of the HMI device can be cleaned when it is switched on and a project is running. An operating element must be available in the project that can be used to call the "clean" screen. Once the clean screen is activated, touch screen operation is locked for a configured period of time. The time the touch screen is locked can be set between 5 and 30 seconds. The time remaining for the lockout is indicated by a progress bar.

NOTICE

Unintentional responses

When cleaning the touch screen, an unintentional response in the PLC can be triggered by touching keys.

Always open the clean screen or switch off the HMI device before you clean the touch screen while the system is running.

Cannot be operated when the clean screen is active

When the clean screen is active, operations on the HMI device are not possible.

Wait for the period for the clean screen to lapse. Then you can operate the plant again with the HMI device.

No clean screen with HMI devices with touch screen and function keys

The clean screen is not available for HMI devices with touch screen and function keys. In this case, configure a screen without operator controls, for example.

7.3 Spare parts and repairs

Repairs

In case of repair, the HMI device must be shipped to the Return Center in Fürth. Repairs may only be carried out at the Return Center in Fürth.

Depending on the work necessary to repair the device, the Center may decide to give you a credit note. A credit note is only granted when the sender orders a new HMI device.

The address is:

Siemens AG
Industry Sector
Returns Center
Siemensstr. 2
90766 Fürth
Germany

Spare parts

You can find spare parts and accessories for the HMI devices in the section Accessories (Page 21).

7.4 Recycling and disposal

The HMI devices described in these operating instructions can be recycled due to the low levels of pollutants. Contact a certified disposal service company for environmentally sound recycling and disposal of your old devices.

Technical specifications

8.1 Certificates and approvals

Approvals

 CAUTION
The following overview shows possible approvals. The HMI device itself is certified as shown on the rear panel labels.

CE approval



The HMI device meets the general and safety-related requirements of the EMC Directive (2004/108/EC "Electromagnetic Compatibility") and conforms to the harmonized European standards (EN) for programmable logic controllers published in the official gazettes of the European Union:

- 94/9/EU "Devices and protection systems for use as prescribed in potentially explosive areas" (Guidelines for Explosion Protection)
- **EC Declaration of Conformity**

The EC Declarations of Conformity are available to the relevant authorities at the following address:

Siemens Aktiengesellschaft
Industry Sector
I IA AS FA WF AMB
PO Box 1963
D-92209 Amberg, Germany

UL approval



Underwriters Laboratories Inc., to

- UL 508 (Industrial Control Equipment)
- CSA C22.2 No. 142 (Process Control Equipment)

or



Underwriters Laboratories Inc., to

- UL 508 (Industrial Control Equipment)
- CSA C22.2 No. 142 (Process Control Equipment)
- UL 1604 (Hazardous Location)
- CSA-213 (Hazardous Location)

Approved for use in

- Class I, Division 2, Group A, B, C, D or
- Class I, Zone 2, Group IIC or
- non-hazardous locations

FM Approval



Factory Mutual Research (FM) conforming to

- Approval Standard Class Number 3611, 3600, 3810
- CSA C22.2 No. 213
- CSA C22.2 No. 1010.1

Approved for use in

- Class I, Division 2, Group A, B, C, D T4
- Class I, Zone 2, Group IIC T4

Ex approval

The following approvals apply to the HMI device in accordance with

- EN 60079-0:2009
- EN 60079-15:2005
- EN 60079-31:2009

valid:

	II 3 G	Ex nA IIC Tx Gc
	II 3 D	Ex tc IIIC T 70 °C Dc IP65 x: Temperature values, see EC design examination certificate

The EC type examination certificates are available on the Internet at:

Technical Support (http://www.siemens.de/automation/csi_en_WW)

The table below describes the test numbers of the HMI device classes:

Manufacturer site	HMI device class	Test number
Siemens AG Industry Sector Werner-von-Siemens-Straße 50 D-92209 Amberg, Germany	Comfort Panel	DEKRA11ATEX0005X

Marking for Australia



The HMI device fulfills the requirements of standard AS/NZS 2064 (Class A).

IEC 61131

The HMI device fulfills requirements and criteria to IEC 61131-2, Programmable Logic Controllers, Part 2: Operating resource requirements and tests.

See also

Currently valid certificates on the Internet

(<http://support.automation.siemens.com/WW/view/en/47182890/134200>)

KOREA



This product meets the requirements of Korean certification.

This product satisfies the requirement of the Korean Certification (KC Mark).

이 기기는 업무용(A급) 전자파 적합기기로서 판매자 또는 사용자는 이 점을 주의하시기 바라며 가정 외의 지역에서 사용하는 것을 목적으로 합니다.

8.2 Directives and declarations

8.2.1 Electromagnetic compatibility

Introduction

The HMI device fulfills, among other things, the requirements of the EMC law pertaining to the domestic European market.

EMC-compatible installation of the HMI device

The EMC-compliant installation of the HMI device and the application of interference-proof cable is the basis for interference-free operation. The "Directives for interference-free installation of PLCs" and the "PROFIBUS Networks" manual also apply for the installation of the HMI device.

Pulse-shaped disturbance

The following table shows the electromagnetic compatibility of modules with regard to pulse-shaped interference. The precondition for electromagnetic compatibility is that the HMI device meets the specifications and guidelines for electrical installation.

Pulse-shaped interference	Tested with	Degree of severity
Electrostatic discharge in accordance with IEC 61000-4-2	Air discharge: 8 kV Contact discharge: 6 kV	3
Burst pulses (high-speed transient interference) in accordance with IEC 61000-4-4	2 kV signal cable with 24 V DC 2 kV signal/data cable > 30 m 1 kV signal cable < 30 m	3
High-energy single pulse (surge) in accordance with IEC 61000-4-5 ¹	Asymmetrical coupling: <ul style="list-style-type: none"> • 2 kV supply line DC voltage with protective elements • 2 kV signal/data cable > 30 m, optional protective elements Symmetrical coupling: <ul style="list-style-type: none"> • 1 kV supply line DC voltage with protective elements • 1 kV signal cable > 30 m, optional protective elements 	3

¹ External protective circuit required; please refer to the S7-300 automation system installation manual, Installation, "Lightning and overvoltage protection" section

The S7-300 automation system installation manual, Installation, is available to download from the Internet (<http://support.automation.siemens.com/WW/view/en/15390415>).

Sinusoidal interference

The following table shows the EMC behavior of the modules with respect to sinusoidal interference. This requires the HMI device to meet the specifications and directives for electrical installation.

Sinusoidal interference	Test values	Degree of severity
HF radiation (in electromagnetic fields) in accordance with IEC 61000-4-3	80% amplitude modulation at 1 kHz <ul style="list-style-type: none"> • to 10 V/m from 80 MHz to 1 GHz • to 10 V/m from 1.4 GHz to 2 GHz • to 1 V/m from 2 GHz to 2.7 GHz 	
RF interference current on cables and cable shielding conforming to IEC 61000-4-6	Test voltage 10 V with 80% amplitude modulation at 1 KHz in the 10 KHz to 80 MHz range	

Emission of radio interference

The following table shows the unwanted emissions from electromagnetic fields in accordance with EN 55011 and EN 55016-2-3, Limit Value Class A, Group 1, measured at a distance of 10 m.

From 30 to 230 MHz	< 40 dB ($\mu\text{V/m}$) quasi-peak
From 230 to 1000 MHz	< 47 dB ($\mu\text{V/m}$) quasi-peak

Additional measures

If you want to connect an HMI device to the public power supply system, you must ensure Limit Value Class B in accordance with EN 55022.

8.2.2 ESD guideline

What does ESD mean?

An electronic module is equipped with highly integrated components. Due to their design, electronic components are highly sensitive to overvoltage and thus to the discharge of static electricity. Such electronic components or modules are labeled as electrostatic sensitive devices.

The following abbreviations are commonly used for electrostatic sensitive devices:

- ESD – Electrostatic sensitive device
- ESD – Electrostatic Sensitive Device as a common international designation

Electrostatic sensitive devices can be labeled with an appropriate symbol.



CAUTION
Damage to ESD from touch
Electrostatic sensitive devices, ESD, can be destroyed by voltages which are far below the human perception limit. If you touch a component or electrical connections of a module without discharging any electrostatic energy, these voltages may arise.
The damage to a module by an overvoltage can often not be immediately detected and only becomes evident after an extended period of operation. The consequences are incalculable and range from unforeseeable malfunctions to a total failure of the machine or plant.
Avoid touching components directly. Make sure that persons, the workstation and the packaging are properly grounded.

Charge

Every person without a conductive connection to the electrical potential of his/her surroundings can be electrostatically charged.

The material with which this person comes into contact is of particular significance. The figure shows the maximum electrostatic voltages with which a person is charged, depending on humidity and material. These values conform to the specifications of IEC 61000-4-2.

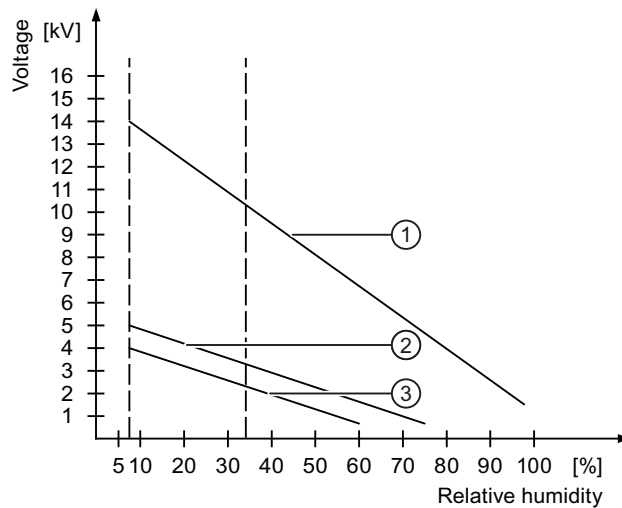

- ① Synthetic materials
- ② Wool
- ③ Antistatic materials such as wood or concrete

CAUTION

Grounding measures

There is no equipotential bonding without grounding. An electrostatic charge is not discharged and may damage the ESD.

Protect yourself against discharge of static electricity. When working with electrostatic sensitive devices, make sure that the person and the workplace are properly grounded.

Protective measures against discharge of static electricity

- Disconnect the power supply before you install or remove modules which are sensitive to ESD.
- Pay attention to good grounding:
 - When handling electrostatic sensitive devices, make sure that persons, the workstation and devices, tools and packaging used are properly grounded. In this manner, you avoid static discharge.
- Avoid direct contact:
 - As a general rule, do not touch electrostatic sensitive devices, except in the case of unavoidable maintenance work.
 - Hold the modules at their edge so that you do not touch the connector pins or conductor paths. In this way, the discharge energy does not reach and damage the sensitive components.
 - Discharge your body electrostatically before you take a measurement at a module. Do so by touching grounded metallic parts. Always use grounded measuring instruments.

8.3 Dimension drawings

8.3.1 Dimension drawings of the FKP400 Comfort

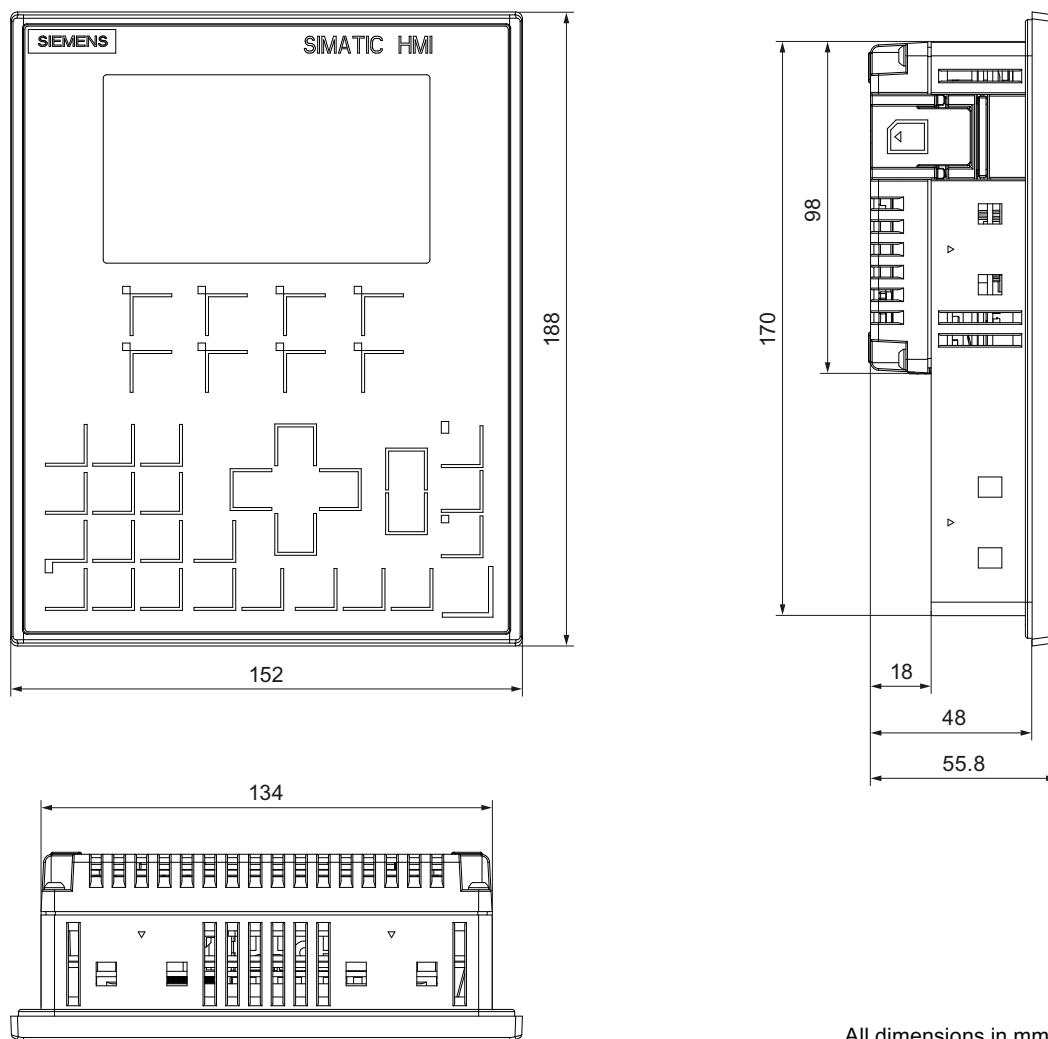

All dimensions in mm.

8.3.2 Dimension drawings of the KP700 Comfort

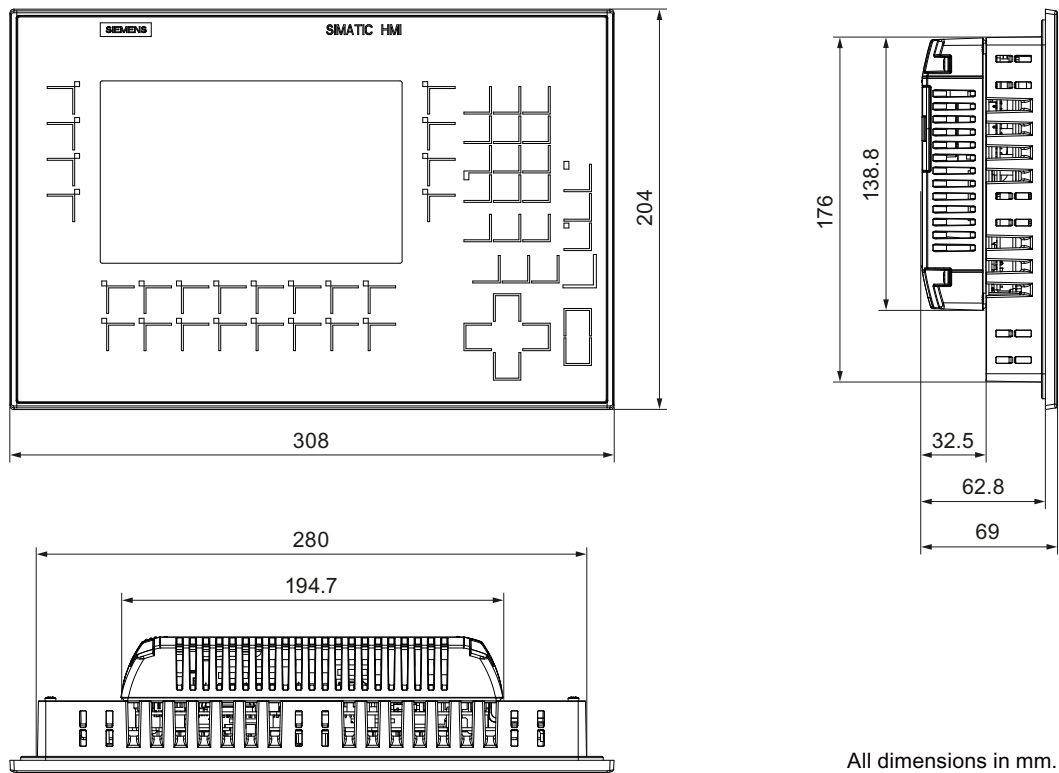

All dimensions in mm.

8.3.3 Dimension drawings of the KP900 Comfort

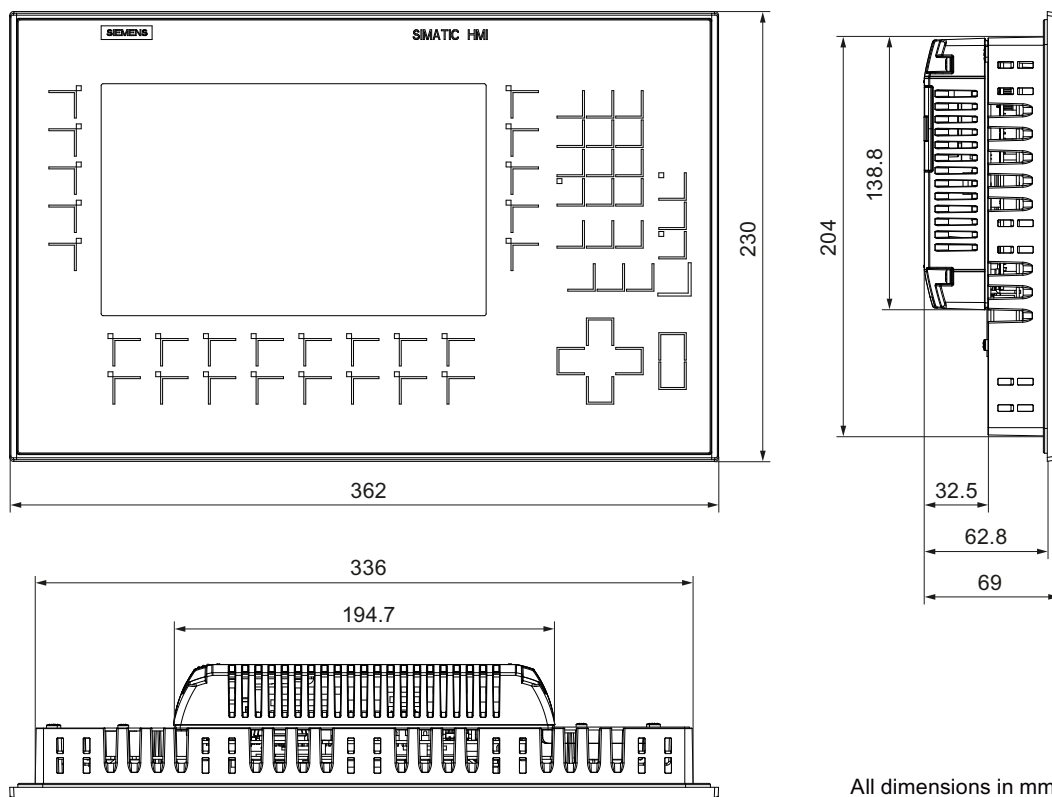

8.3.4 Dimension drawings of the KP1200 Comfort

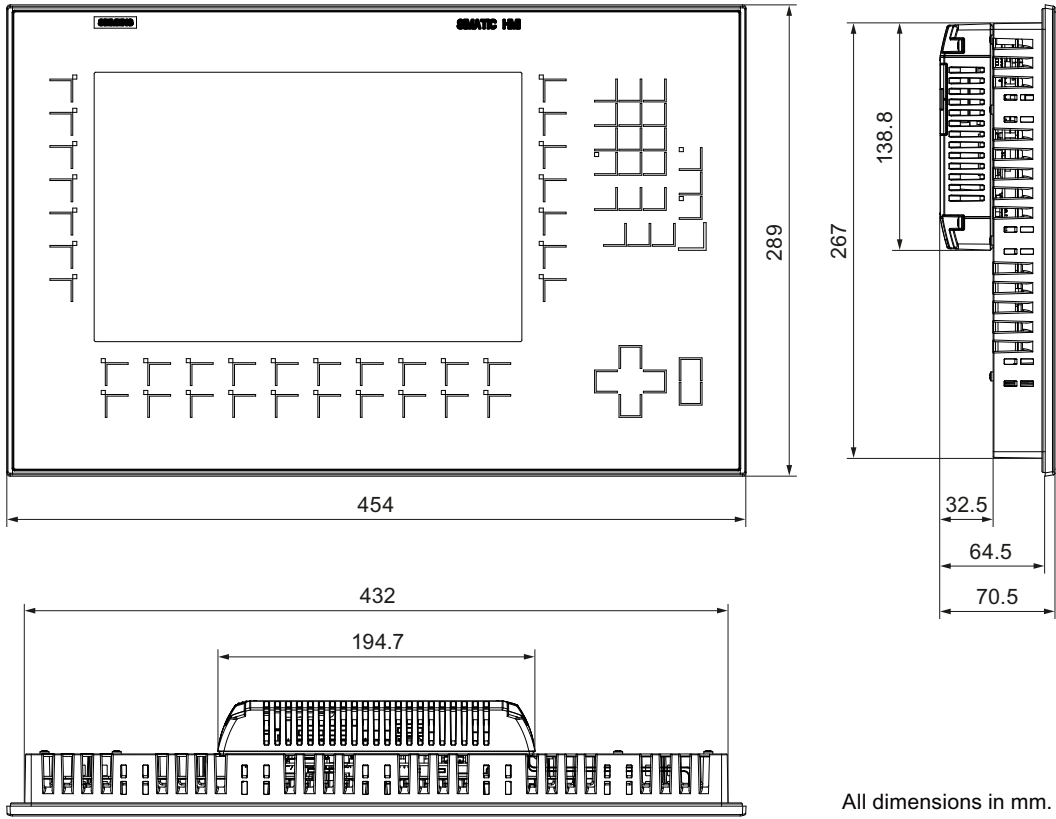

8.3.5 KP1500 Comfort dimension drawings

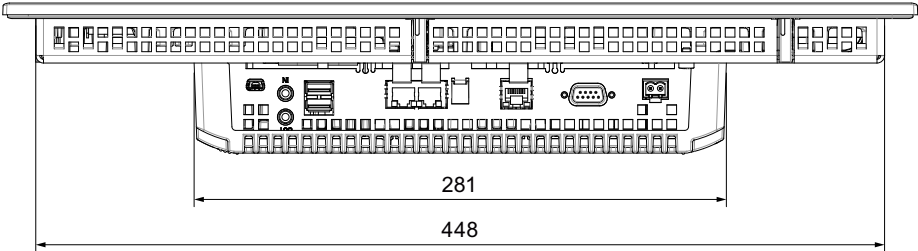

All dimensions in mm.

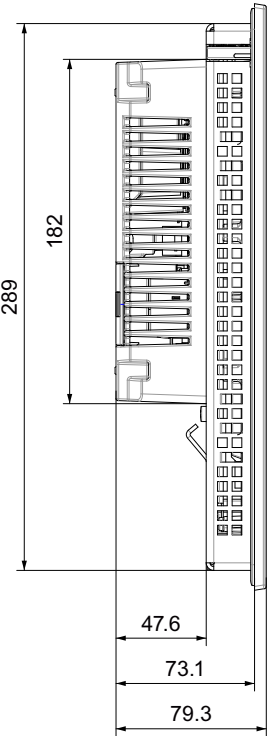
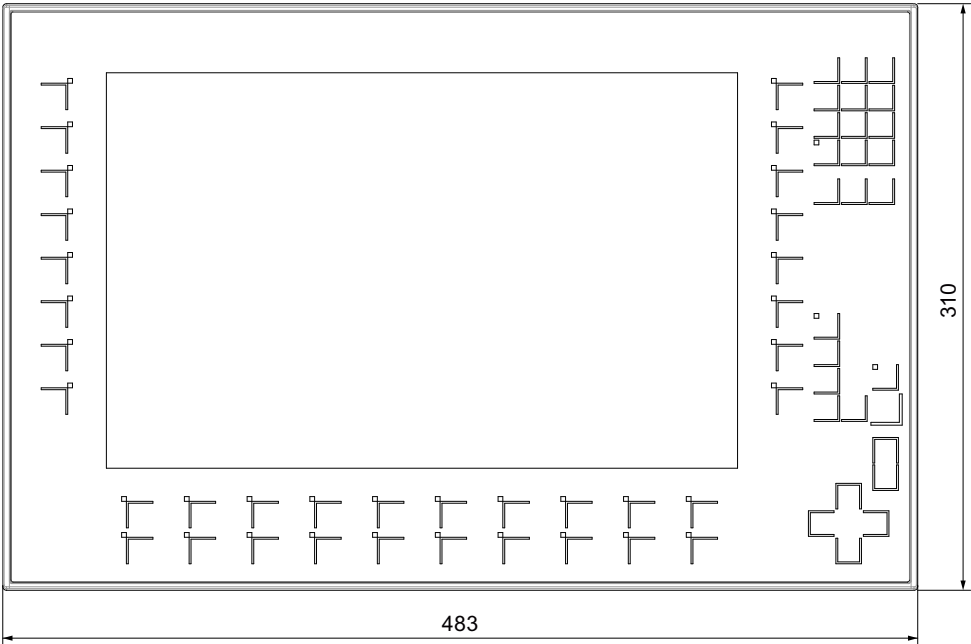

8.3.6 Dimension drawings of the KTP400 Comfort

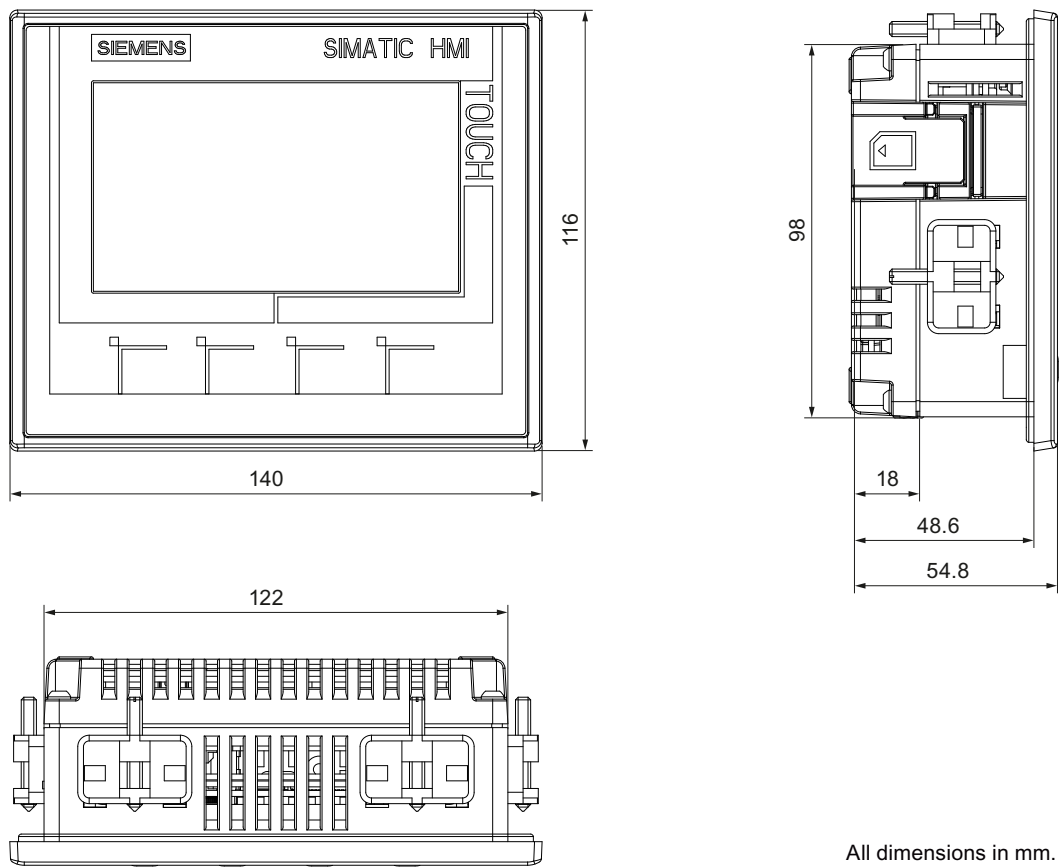

All dimensions in mm.

8.3.7 Dimension drawings of the TP700 Comfort

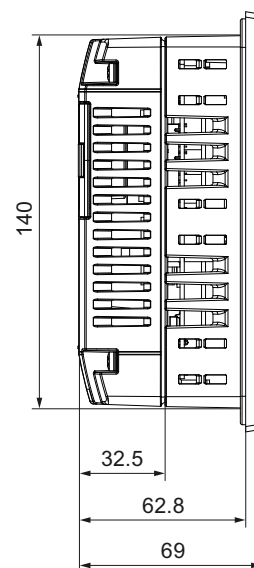
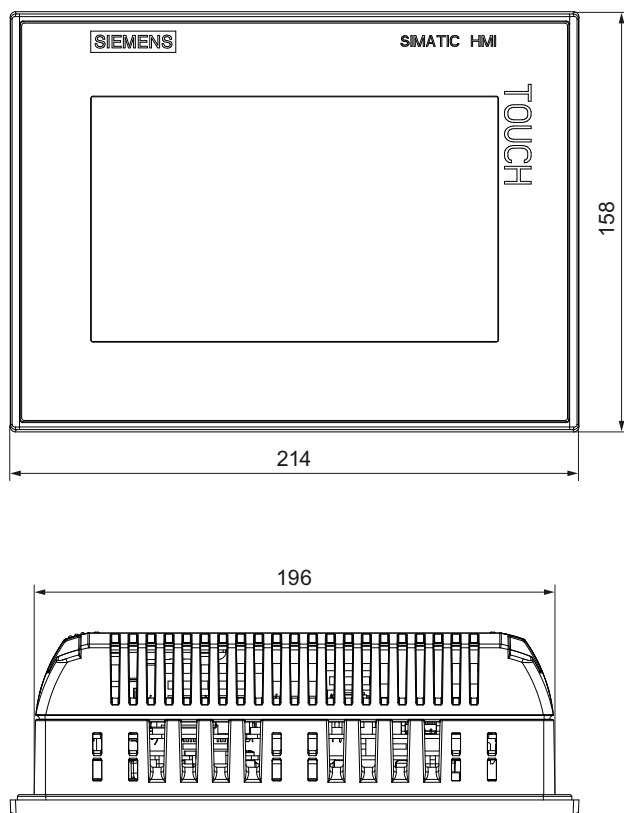

All dimensions in mm.

8.3.8 Dimension drawings of the TP900 Comfort

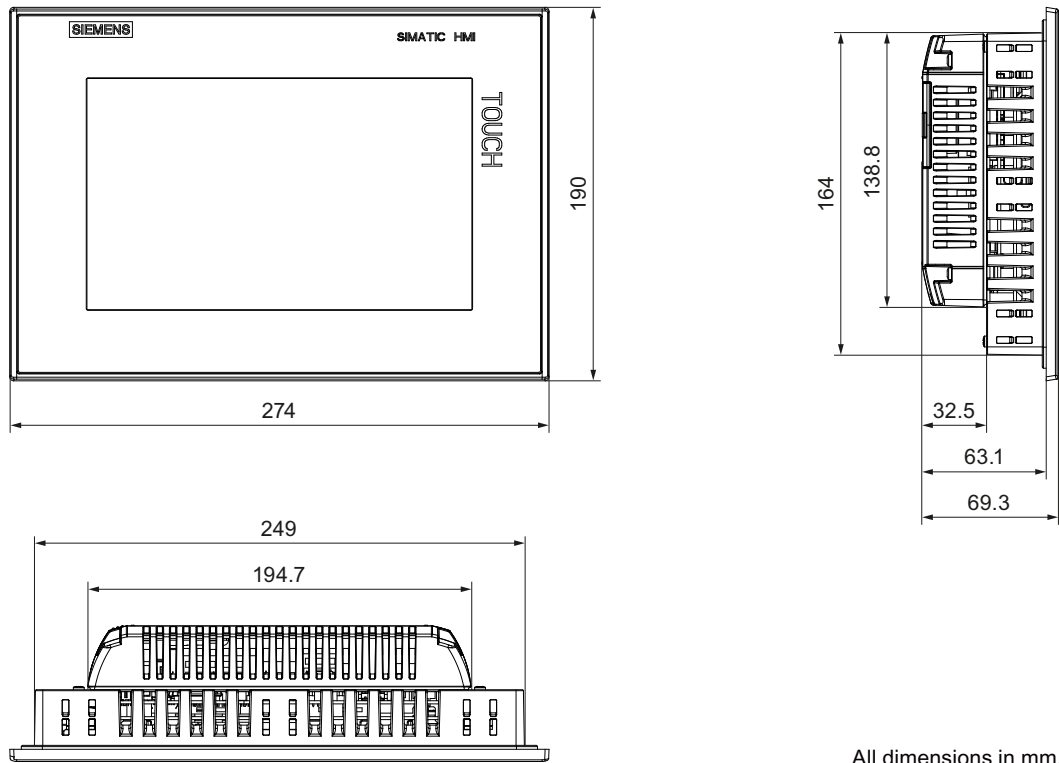

All dimensions in mm.

8.3.9 Dimension drawings of the TP1200 Comfort

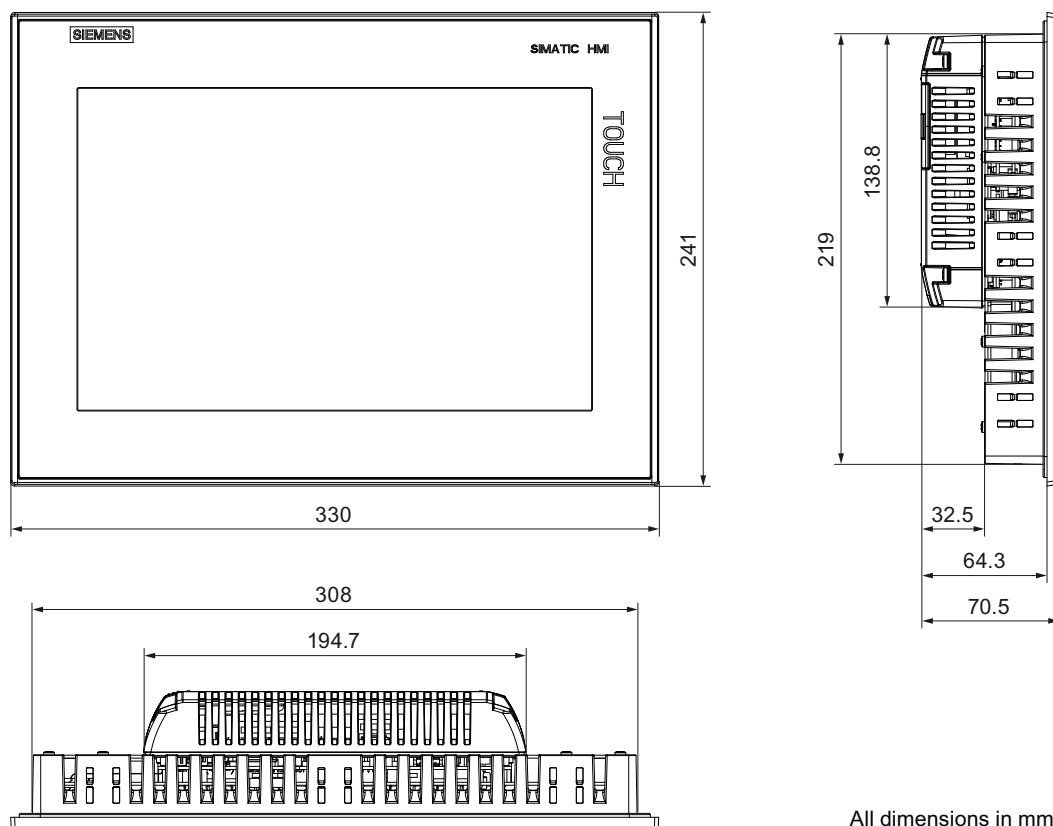

All dimensions in mm.

8.3.10 Dimension drawings of TP1500 Comfort

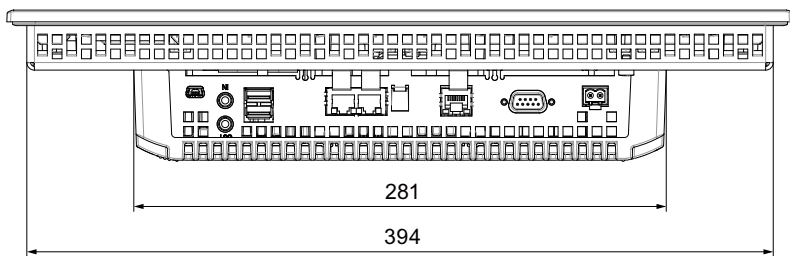

All dimensions in mm.

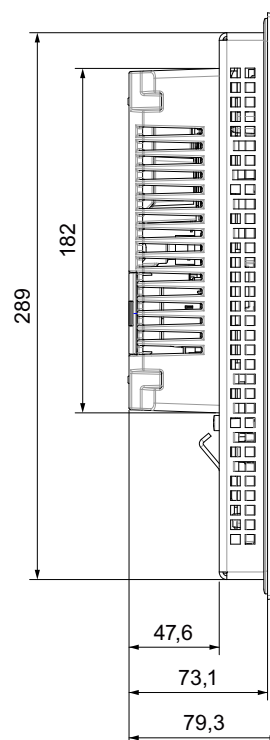

8.3.11 Dimension drawings of TP1900 Comfort

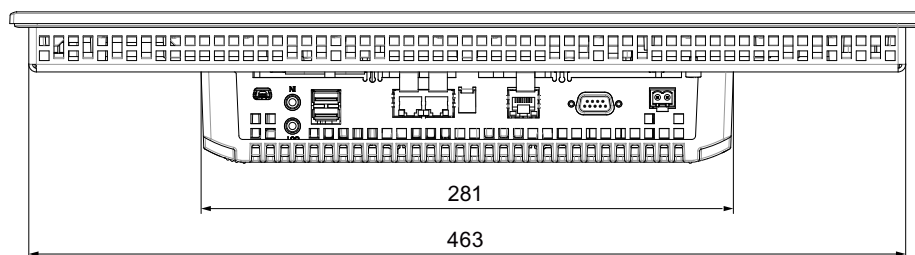

All dimensions in mm.

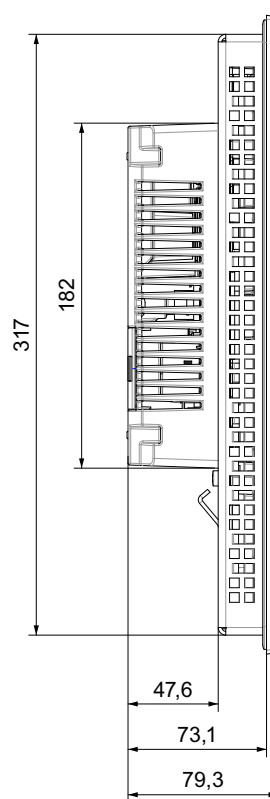

8.3.12 Dimension drawings of TP2200 Comfort

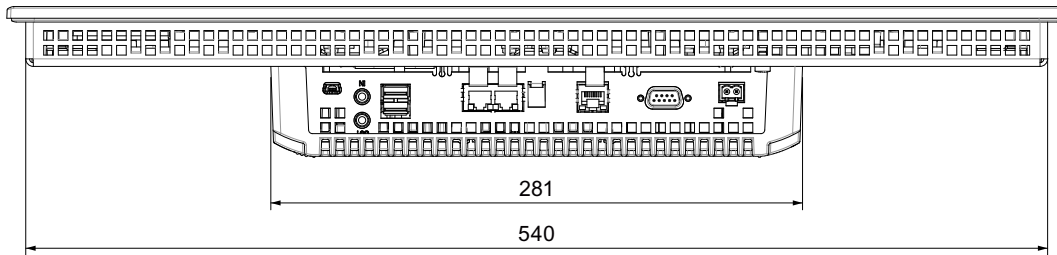

All dimensions in mm.

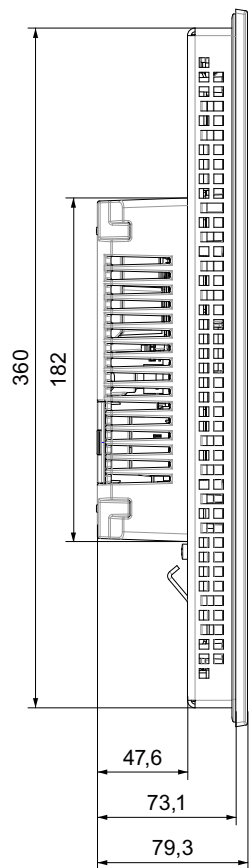
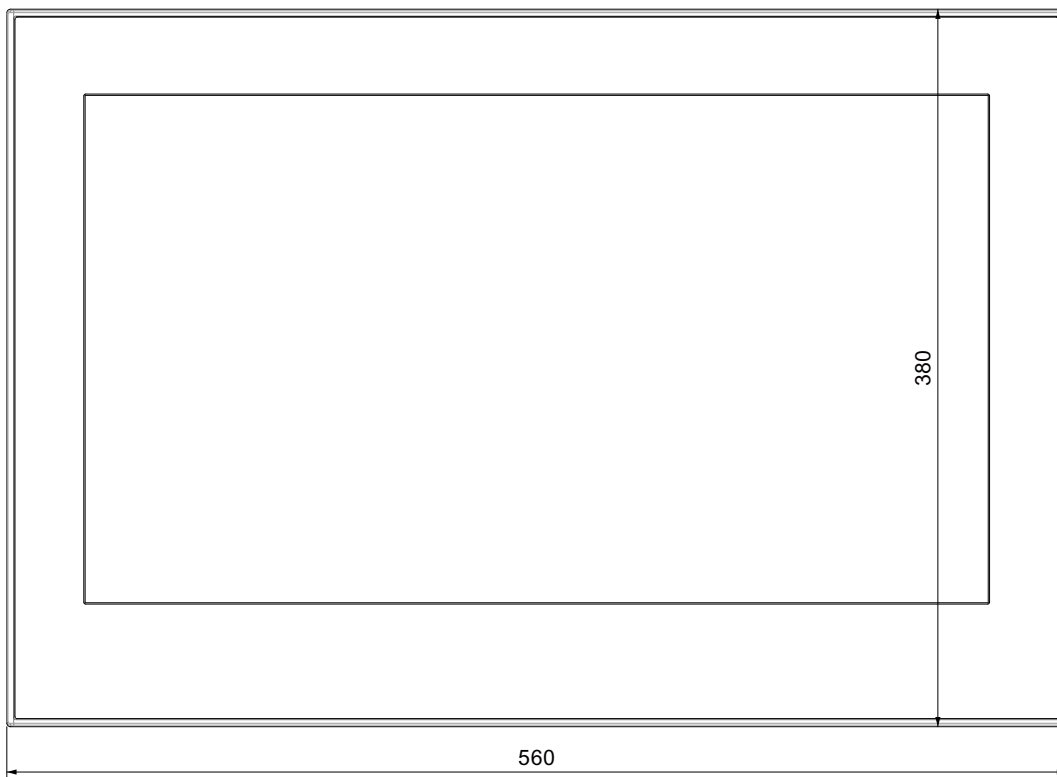

8.3.13 Dimensions for labeling strips

This section contains the labeling strip dimensions for the Comfort Panels key models. You will find labeling strip templates with a scale of 1:1 as a Word file:

- On the Internet at:
Downloads for Comfort Panels
(<http://support.automation.siemens.com/WW/view/en/47182890/133100>)
- In the "Support" folder on the WinCC installation DVD

Labeling strips for KP400 Comfort and KTP400 Comfort

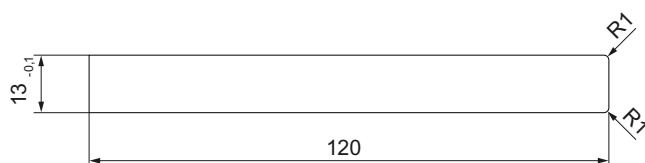

Labeling strips for KP700 Comfort

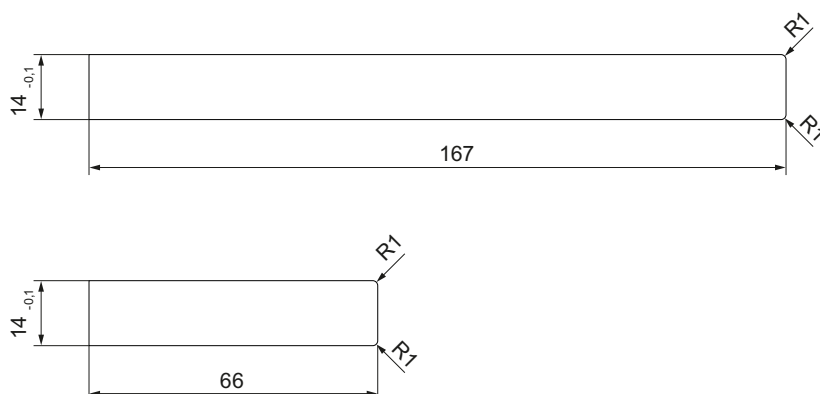

Labeling strips for KP900 Comfort

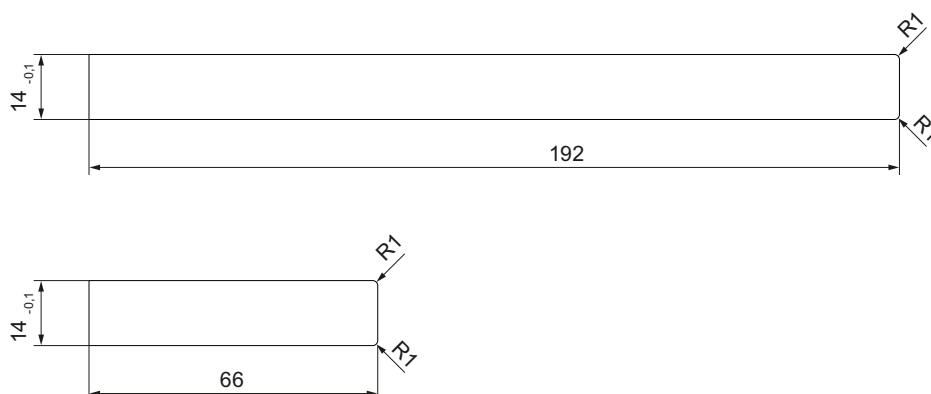

Labeling strips for KP1200 Comfort

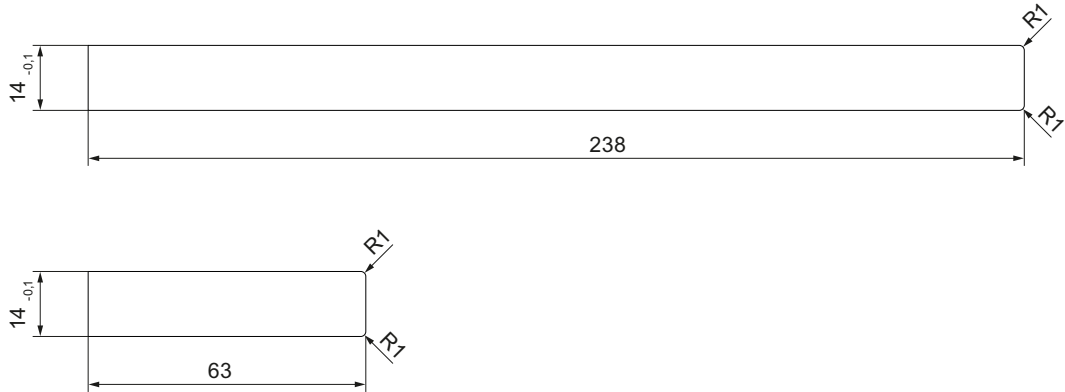

Labeling strips for KP1500 Comfort

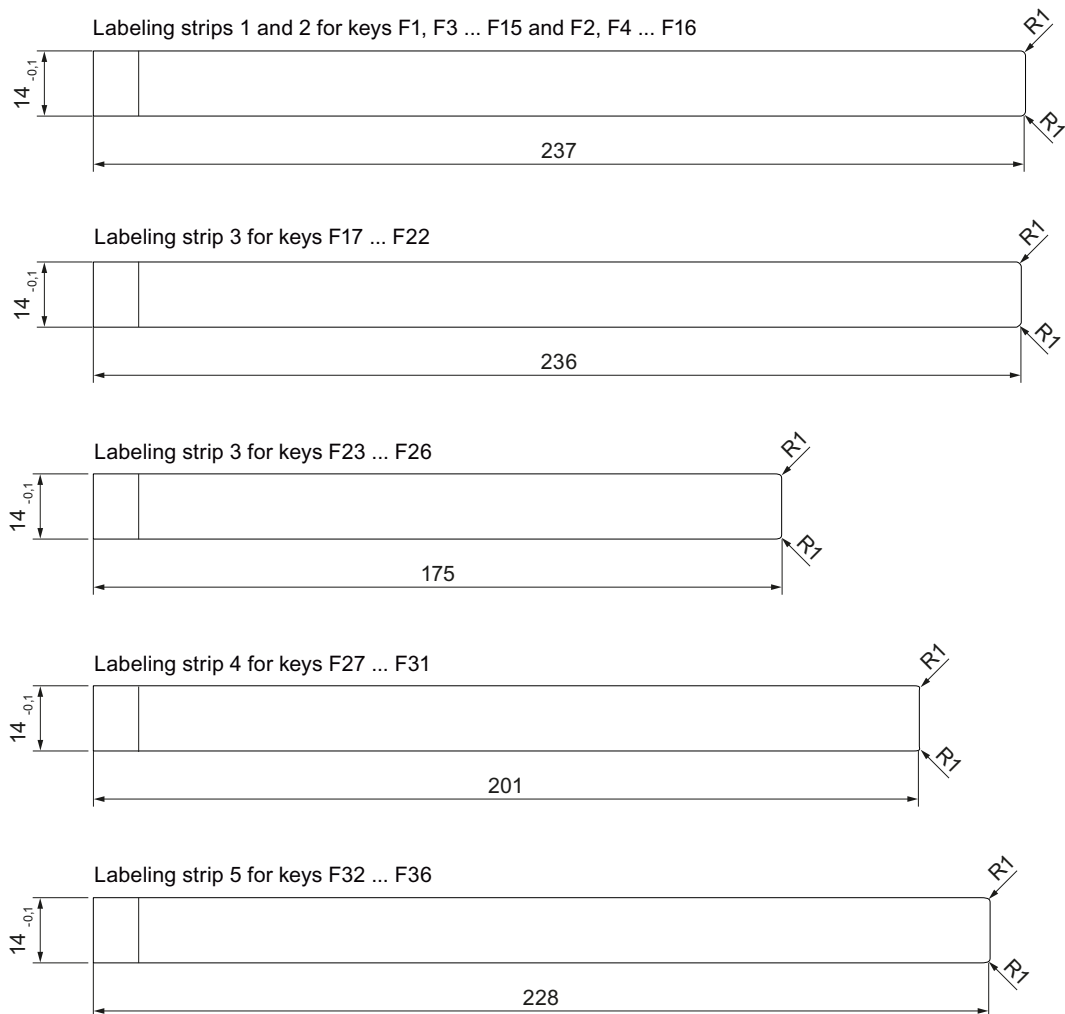

8.4 Technical specifications

8.4.1 KP400 Comfort to KP1200 Comfort, KTP400 Comfort to TP1200 Comfort

Weight

	HMI devices							
	KP400 C omfort	KTP400 Comfort	KP700 Comfort	TP700 Comfort	KP900 Comfort	TP900 Comfort	KP1200 Comfort	TP1200 Comfort
Weight without packaging	0.8 kg	0.6 kg	2.2 kg	1.4 kg	2.7 kg	1.9 kg	4.4 kg	2.8 kg

Display

	HMI devices							
	KP400 C omfort	KTP400 Comfort	KP700 Comfort	TP700 Comfort	KP900 Comfort	TP900 Comfort	KP1200 Comfort	TP1200 Comfort
Type	LCD TFT with extended viewing angle							
Active display area	4,3" 95 mm x 53 mm		7,0" 152 mm x 91 mm		9,0" 195 mm x 117 mm		12,1" 261 mm x 163 mm	
Resolution	480 x 272 pixels		800 x 480 pixels				1280 x 800 pixels	
Possible colors	Up to 16 million							
Brightness control	Yes, from 0 to 100 ¹ , 0 = backlighting off							
Backlighting	LED							
Half Brightness Life Time (MTBF ²)	80000 h							
Pixel error class in accordance with ISO 9241-307	II			I				

¹ Via WinCC: Complete range, via Control Panel: Minimum to 100

² MTBF: Operating hours after which the maximum brightness is reduced by half compared to the original value. MTBF is increased by using the integrated dimming function, for example time-controlled via screen saver or centrally via PROFIenergy.

Input device

	HMI devices							
	KP400 C omfort	KTP400 Comfort	KP700 Comfort	TP700 Comfort	KP900 Comfort	TP900 Comfort	KP1200 Comfort	TP1200 Comfort
Keyboard (numeric/alpha entry)	Yes	Yes	Yes	No	Yes	No	Yes	No
Touch screen (analog resistive)	No	Yes	No	Yes	No	Yes	No	Yes
Function keys	8	4	24	No	26	No	34	No
Labeling strips	Yes	Yes	Yes	No	Yes	No	Yes	No

Memory

	HMI devices							
	KP400 C omfort	KTP400 Comfort	KP700 Comfort	TP700 Comfort	KP900 Comfort	TP900 Comfort	KP1200 Comfort	TP1200 Comfort
Usable memory for application data	4 MB		12 MB					
Usable memory for recipe data ¹	512 KB		2 MB					
Additional memory for options	4 MB		12 MB					
Memory card	2 x MMC/SD combination slot							

¹ Can be extended via memory card

Interfaces

	HMI devices							
	KP400 C omfort	KTP400 Comfort	KP700 Comfort	TP700 Comfort	KP900 Comfort	TP900 Comfort	KP1200 Comfort	TP1200 Comfort
1 x RS 422/485 (PROFIBUS)	Max. 12 Mbps, applies to DP operations							
Ethernet (PROFINET)	1 x RJ45 10/100 Mbps		2 x RJ45 10/100 Mbps ¹					
Audio	-		Line In and Line Out					
USB 2.0	1 x Host ²⁾ 1 x Device ³⁾		2 x Host ²⁾ 1 x Device ³⁾					

¹ With integrated switch (one IP address only)

² USB type A, maximum load 500 mA, equivalent to USB standard 2.0

³ USB type Mini B (5-pin), equivalent to USB standard 2.0

Power supply

	HMI devices							
	KP400 C omfort	KTP400 Comfort	KP700 Comfort	TP700 Comfort	KP900 Comfort	TP900 Comfort	KP1200 Comfort	TP1200 Comfort
Rated voltage	24 V DC							
Permissible voltage range	+19.2 V to +28.8 V							
Rated current	0.13 A		0.5 A		0.75 A		0.85 A	
Inrush current I ² t	0.5 A ² s							
Power	3.1 W		12 W		18 W		20 W	
Maximum permissible transient	35 V (500 ms)							
Minimum time between two transients	50 s							
Internal protection	Electronic							

Miscellaneous

	HMI devices							
	KP400 Comfort	KTP400 Comfort	KP700 Comfort	TP700 Comfort	KP900 Comfort	TP900 Comfort	KP1200 Comfort	TP1200 Comfort
Buffered real-time clock ¹	Yes							
Audio reproduction	Onboard beeper		Integrated or external via Line OUT					
Magnetic field intensity	50/60 Hz; 100 A/m RMS							

¹ Battery backup typically 6 weeks

8.4.2 KP1500 Comfort, TP1500 Comfort to TP2200 Comfort

Weight

	HMI devices			
	KP1500 Comfort	TP1500 Comfort	TP1900 Comfort	TP2200 Comfort
Weight without packaging	5.4 kg	5.2 kg	6.5 kg	7.1 kg

Display

	HMI devices			
	KP1500 Comfort	TP1500 Comfort	TP1900 Comfort	TP2200 Comfort
Type	LCD TFT with extended viewing angle		LCD TFT	LCD TFT with extended viewing angle
Active display area	15,4" 331 x 207 mm		18,5" 410 x 230 mm	21,5" 475 x 267 mm
Resolution	1280 x 800 pixels		1366 x 768 pixels	1920 x 1080 pixels
Possible colors	Up to 16 million			
Brightness control	Yes, from 0 to 100 ¹ , 0 = backlighting off			
Backlighting	LED		LED	LED
Half Brightness Life Time (MTBF ²)	80000 h		50000 h	30000 h
Pixel error class in accordance with ISO 9241-307	I			

¹ Via WinCC: Complete range, via Control Panel: Minimum to 100

² MTBF: Operating hours after which the maximum brightness is reduced by half compared to the original value. MTBF is increased by using the integrated dimming function, for example time-controlled via screen saver or centrally via PROFenergy.

Input device

	HMI devices			
	KP1500 Comfort	TP1500 Comfort	TP1900 Comfort	TP2200 Comfort
Keyboard (numeric/alpha entry)	Yes	No		
Touch screen (analog resistive)	No	Yes		
Function keys	36	No		
Labeling strips	Yes	No		

Memory

	HMI devices			
	KP1500 Comfort	TP1500 Comfort	TP1900 Comfort	TP2200 Comfort
Usable memory for application data	24 MB			
Usable memory for recipe data ¹	4 MB			
Additional memory for options	24 MB			
Memory card	2 x MMC/SD combination slot			

¹ Can be extended via memory card

Interfaces

	HMI devices			
	KP1500 Comfort	TP1500 Comfort	TP1900 Comfort	TP2200 Comfort
1 x RS 422/485 (PROFIBUS)	Max. 12 Mbps, applies to DP operations			
Ethernet (PROFINET)	2 x RJ45 10/100 Mbps ¹			
Ethernet (PROFINET basic functionality)	1 x RJ45 10/100/1000 Mbps			
Audio	Line In and Line Out			
USB 2.0	2 x Host ² 1 x Device ³			

¹ With integrated switch (one IP address only)

² USB type A, maximum load 500 mA, equivalent to USB standard 2.0

³ USB type Mini B (5-pin), equivalent to USB standard 2.0

Power supply

	HMI devices			
	KP1500 Comfort	TP1500 Comfort	TP1900 Comfort	TP2200 Comfort
Rated voltage	24 V DC			
Permissible voltage range	+19.2 V to +28.8 V			
Rated current	1.5 A		1.3 A	2.2 A
Inrush current I ² t	0.5 A ² s			
Power	36 W		32 W	53 W
Maximum permissible transient	35 V (500 ms)			
Minimum time between two transients	50 s			
Internal protection	Electronic			

Miscellaneous

	HMI devices			
	KP1500 Comfort	TP1500 Comfort	TP1900 Comfort	TP2200 Comfort
Buffered real-time clock ¹	Yes			
Audio reproduction	Integrated or external via Line OUT			
Magnetic field intensity	50/60 Hz; 100 A/m RMS			

¹ Battery backup typically 6 weeks

8.4.3 Ambient conditions

8.4.3.1 Transport and storage conditions

Mechanical and climatic conditions for transportation and storage

This HMI device meets the requirements for IEC 61131-2 relating to transport and storage conditions. The following specifications apply to the transport and storage of an HMI device in its original packaging.

The climatic conditions conform to the following standards:

- IEC 60721-3-2, Class 3K7 for storage
- IEC 60721-3-2, Class 2K4 for transport

The mechanical conditions correspond to IEC 61131-2.

Type of condition	Permitted range	
Drop test (in transport package)	≤ 1 m	
Temperature	From -20 to +60° C	
Atmospheric pressure	From 1080 to 660 hPa, Corresponds to an elevation of -1 000 to 3 500 m	
Relative humidity	From 10 to 90%, without condensation	
Sinusoidal vibration in accordance with IEC 60068-2-6	KP/KTP400 Comfort: 5 to 9 Hz: 3.5 mm 9 to 150 Hz: 9.8 m/s ²	KP/TP700 to 2200 Comfort: 5 to 8.4 Hz: 3.5 mm 8.4 to 500 Hz: 9.8 m/s ²
Shock according to IEC 60068-2-27 for KP/KTP400 Comfort IEC 60068-2-29 for KP/TP700 to 2200 Comfort	250 m/s ² , 6 ms, 1000 shocks	

NOTICE

Avoid dewing

If the HMI device is subjected to low temperatures or extreme fluctuations in temperature during transportation, moisture could occur on or inside the HMI device. Dewing can occur. This can cause malfunctions.

The HMI device must have acquired room temperature before it is put into operation. Do not expose the HMI device to direct radiation from a heater in order to warm it up. If there is condensation, wait approximately four hours until the HMI device has dried completely before switching it on.

Proper transport and storage, installation and assembly as well as careful operation and maintenance are required to ensure trouble-free and safe operation of the HMI device.

The warranty for the HMI device will be deemed void if these stipulations are not heeded.

8.4.3.2 Operating conditions

Mechanical and climatic conditions of use

The HMI device is designed for use in a location protected from the effects of the weather. The conditions of use meet the requirements for DIN IEC 60721-3-3:

- Class 3M3 (mechanical requirements)
- Class 3K3 (climatic requirements)

Use with additional measures

The HMI device should not be used at the following locations unless additional measures are taken:

- In locations with a high degree of ionizing radiation
- In locations with severe operating conditions, for example, due to:
 - Corrosive vapors, gases, oils or chemicals
 - Electrical or magnetic fields of high intensity
- In plants that require special monitoring - for example:
 - Elevators
 - Systems in especially hazardous rooms

Mechanical ambient conditions

The mechanical ambient conditions for the HMI device are specified in the following table in terms of sinusoidal vibration.

Frequency range f in Hz	Constant	Occasional
5 Hz ≤ f ≤ 8.4 Hz ¹	Amplitude 0.0375 mm	Amplitude 0.075 mm
8.4 Hz ≤ f ≤ 150 Hz	Constant acceleration 0.5 g	Constant acceleration 1 g

¹ Frequency range for KP/KTP 400 Comfort: 5 Hz ≤ f ≤ 9 Hz

Reducing vibrations

If the HMI device is subjected to greater shocks or vibrations, you must take appropriate measures to reduce acceleration or amplitudes.

We recommend mounting the HMI device on damping materials (on rubber-metal vibration dampers, for example).

Testing mechanical ambient conditions

The following table provides information on the type and scope of tests for mechanical ambient conditions.

Tested for	Test standard	Comments
Vibrations	Vibration test in accordance with IEC 60068, part 2-6 (sinusoidal)	Type of vibration: Frequency cycles at a rate of change of 1 octave/minute. 5 Hz ≤ f ≤ 8.4 Hz, constant amplitude 0.075 mm ¹ 8.4 Hz ≤ f ≤ 150 Hz, constant acceleration 1 g ¹
		Vibration duration: 10 frequency cycles per axis in each of the three mutually vertical axes
Shock	Shock test in accordance with IEC 60068, Part 2 -27	Type of shock: Half-sine
		Severity of shock: Peak value 15 g, duration 11 ms
		Direction of shock: 3 shocks in ± direction of axis in each of the three axes vertical to each other

¹ Frequency range for KP/KTP 400 Comfort: 5 Hz ≤ f ≤ 9 Hz

Climatic ambient conditions

The following table shows the climatic ambient conditions for operation of the HMI device.

Ambient conditions	Permitted range	Comments
Temperature: Vertical mounting	From 0 to 50 °C (horizontal) ¹ From 0 to 40 °C (vertical)	Slope angle max. 35°
Mounting at an angle	From 0 to 40 °C (horizontal) From 0 to 35 °C (vertical)	
Relative humidity	10 to 90%, without condensation	
Atmospheric pressure	1 080 to 795 hPa	Corresponds to an elevation of -1 000 m to 2000 m
Pollutant concentration	SO ₂ : < 0.5 vpm; Relative humidity <60%, no condensation	Test: 10 cm ³ /m ³ ; 10 days
	H ₂ S: < 0.1 vpm; Relative humidity <60%, no condensation	Test: 1 cm ³ /m ³ ; 10 days

¹ TP1900 Comfort and TP2200 Comfort: From 0 to 45° C

8.4.3.3 Information on insulation tests, protection class and degree of protection

Test voltages

Insulation strength is demonstrated in the type test with the following test voltages in accordance with IEC 61131-2:

Circuits with a nominal voltage of U_n to other circuits or ground	Test voltage
24 V	520 V DC or 370 V AC For Ethernet connector: 1500 V AC

Protection class

Protection Class I in accordance with IEC 61140, i.e. PE/ground terminal to profile rail required!

Protection against foreign objects and water

Degree of protection in accordance with IEC 60529	Explanation
Front	When mounted: <ul style="list-style-type: none"> • IP65 • Front face only Type 4X/Type 12 (indoor use only)
Rear panel	IP20 Touch protection test with standard test probes. There is no protection against ingress by water.

The front protection rating can only be guaranteed if the mounting seal lies flush against the mounting cut-out.

8.5 Bit assignment of the direct keys

The following figures show the assignment of the keys and LEDs to the bytes in the PLC process image.

Further information may be available in your plant documentation.

8.5.1 KTP400 Comfort

HMI device	Inputs	Outputs
Touch operation	4 bytes	-

Direct key assignment								Byte	LED	
	7	6	5	4	3	2	1	0		
Touch buttons	7	6	5	4	3	2	1	0	n+0	No output area
	15	14	13	12	11	10	9	8	n+1	
	23	22	21	20	19	18	17	16	n+2	
	31	30	29	28	27	26	25	24	n+3	

HMI device	Inputs	Outputs
Key operation	1 byte	1 byte

Direct key assignment				Byte	LED				
	3	2	1	0		3	2	1	0
Keys	F4	F3	F2	F1	n+0	F4	F3	F2	F1

8.5.2 KP400 Comfort

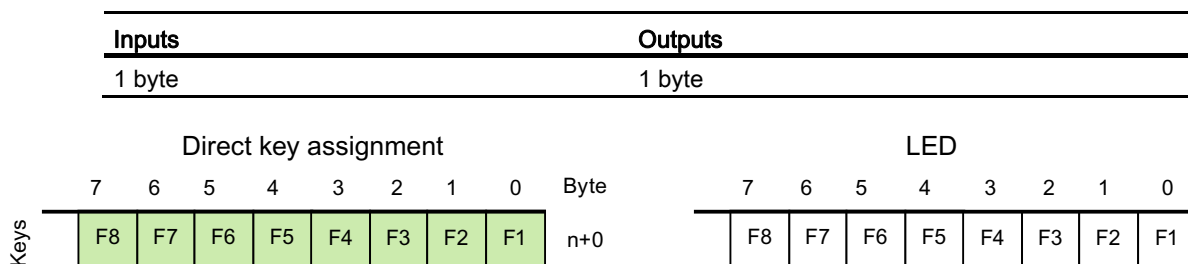

8.5.3 KP700 Comfort

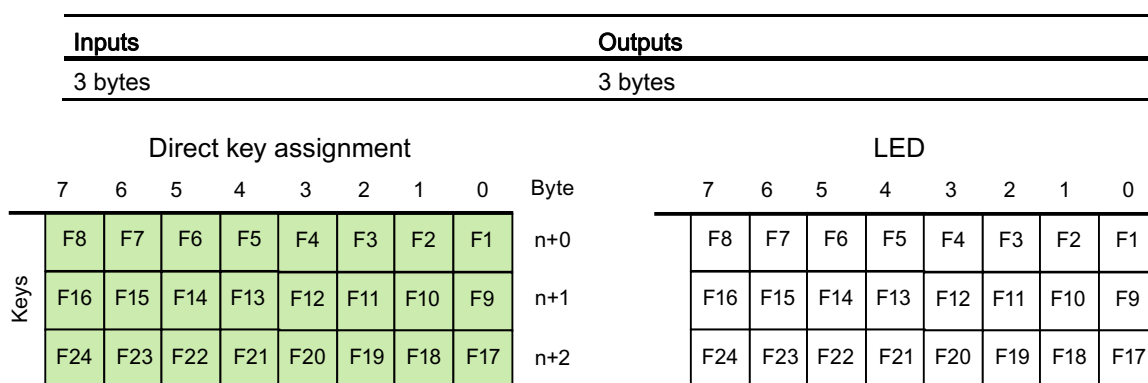

8.5.4 TP700 Comfort

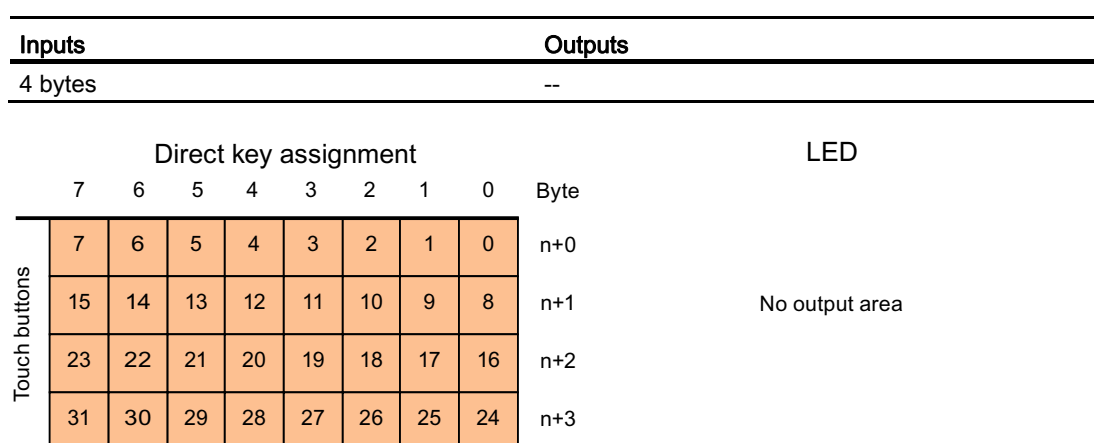

8.5.5 KP900 Comfort

Inputs	Outputs
4 bytes	4 bytes

Direct key assignment

	7	6	5	4	3	2	1	0	Byte
Keys	F8	F7	F6	F5	F4	F3	F2	F1	n+0
	F16	F15	F14	F13	F12	F11	F10	F9	n+1
	F24	F23	F22	F21	F20	F19	F18	F17	n+2
							F26	F25	n+3

LED

	7	6	5	4	3	2	1	0
	F8	F7	F6	F5	F4	F3	F2	F1
	F16	F15	F14	F13	F12	F11	F10	F9
	F24	F23	F22	F21	F20	F19	F18	F17
							F18	F17

8.5.6 TP900 Comfort

Inputs	Outputs
5 bytes	--

Direct key assignment

	7	6	5	4	3	2	1	0	Byte
Touch buttons	7	6	5	4	3	2	1	0	n+0
	15	14	13	12	11	10	9	8	n+1
	23	22	21	20	19	18	17	16	n+2
	31	30	29	28	27	26	25	24	n+3
	39	38	37	36	35	34	33	32	n+4

LED

No output area

8.5.9 KP1500 Comfort

Inputs	Outputs
5 bytes	5 bytes

Direct key assignment

	7	6	5	4	3	2	1	0	Byte
Keys	F8	F7	F6	F5	F4	F3	F2	F1	n+0
	F16	F15	F14	F13	F12	F11	F10	F9	n+1
	F24	F23	F22	F21	F20	F19	F18	F17	n+2
	F32	F31	F30	F29	F28	F27	F26	F25	n+3
				F36	F35	F34	F33		n+4

LED

	7	6	5	4	3	2	1	0
F8	F7	F6	F5	F4	F3	F2	F1	
F16	F15	F14	F13	F12	F11	F10	F9	
F24	F23	F22	F21	F20	F19	F18	F17	
F32	F31	F30	F29	F28	F27	F26	F25	
				F36	F35	F34	F33	

8.5.10 TP1500, TP1900 and TP2200 Comfort

Inputs	Outputs
5 bytes	--

Direct key assignment

	7	6	5	4	3	2	1	0	Byte
Touch buttons	7	6	5	4	3	2	1	0	n+0
	15	14	13	12	11	10	9	8	n+1
	23	22	21	20	19	18	17	16	n+2
	31	30	29	28	27	26	25	24	n+3
	39	38	37	36	35	34	33	32	n+4

LED

No output area

8.6 Description of the ports

8.6.1 Power supply

Plug connector, 2-pin



Pin number	Assignment
1	+24 VDC (L+)
2	GND 24 V (M)

8.6.2 PROFIBUS (Sub-D RS422/485)

Name of interface on HMI device: X2

Sub-D socket, 9-pin, with screw lock

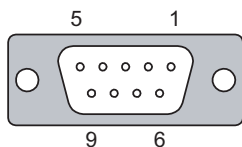

Pin	Assignment for the RS 422	Assignment for the RS 485
1	n. c.	n. c.
2	GND 24 V	GND 24 V
3	TxD+	Data channel B (+)
4	RD+	RTS
5	GND 5 V, floating	GND 5 V, floating
6	+5 VDC, floating	+5 VDC, floating
7	+24 VDC, out (max. 100 mA)	+24 VDC, out (max. 100 mA)
8	TxD-	Data channel A (-)
9	RxD-	NC

8.6.3 PROFINET (LAN) 10/100 Mb

Name of interface on HMI device: X1

RJ45 plug connector

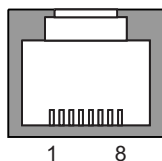

Pin	Assignment
1	Tx+
2	Tx-
3	Rx+
4	n. c.
5	n. c.
6	Rx-
7	n. c.
8	n. c.

8.6.4 PROFINET (LAN) 10/100/1000 Mb

Models of 15" and more have this interface. Name of interface on HMI device: X3

RJ45 plug connector

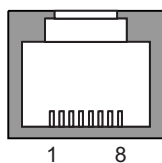

Pin	Assignment
1	D1+
2	D1-
3	D2+
4	D3+
5	D3-
6	D2-
7	D4+
8	D4-

8.6.5 USB

USB socket type A

Name of interface on HMI device: X61/X62

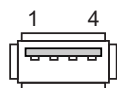

Pin	Assignment
1	+5 VDC, out (max. 500 mA)
2	USB-DN
3	USB-DP
4	GND

USB socket type mini B

Name of interface on HMI device: X60

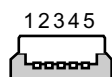

Pin	Assignment
1	-
2	USB-DN
3	USB-DP
4	-
5	GND

8.6.6 Audio (IN/OUT)

Name of interface on HMI device: X90

Line in/out plug

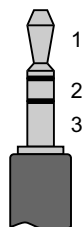

Pin	Assignment
1	Left audio channel
2	Right audio channel
3	GND

8.7 Communication with PLCs

Number of connections

Connection	KP400 Comfort KTP400 Comfort	KP700 Comfort to KP1500 Comfort TP700 Comfort to TP2200 Comfort
Number using a bus connection	4	8
Number of connections based on "SIMATIC HMI HTTP Protocol"	4	8

NOTICE
<p>Communication faults with PROFINET IO</p> <p>If you enable PROFINET services in the Control Panel of the HMI device, communication problems can occur if you use PLCs from other manufacturers.</p> <p>PLCs that are not compatible with PROFINET services are noted in the following table in the footnote. Do not enable PROFINET services for these PLCs.</p>

PLCs

The following table shows the PLCs and the communication drivers which can be used with the HMI devices.

PLC	HMI devices
SIMATIC S7-1200	Yes
SIMATIC S7-300/400	Yes
SIMATIC S7-200	Yes
SIMATIC HTTP protocol	Yes
OPC ¹	Yes
OPC UA	Yes
Allen-Bradley EtherNet/IP	Yes
Allen-Bradley DF1	Yes ^{2, 3}
Mitsubishi MC TCP/IP	Yes
Mitsubishi FX	Yes ³
Modicon Modbus TCP/IP	Yes
Modicon Modbus RTU	Yes ³
Omron Hostlink	Yes ³

¹ OPC-XML DA Server

² Direct communication with PLC 5, with the KF2 module, otherwise approved only via the optional converter RS422-RS232, order number 6AV6 671-8XE00-0AX0.

³ "PROFINET IO Enabled" must be disabled.

8.8 Scope of functions with WinCC

The following tables show the objects which can be integrated in a project for an HMI device.

Note

The specified values are maximum values of the individual objects. Simultaneous use of multiple objects with their maximum value can lead to problems in the active project.

Alarms

Object	Specification	HMI devices		
		KP400 Comfort KTP400 Comfort	KP700 Comfort to KP1200 Comfort, TP700 Comfort to TP1200 Comfort	KP1500 Comfort, TP1500 Comfort to TP2200 Comfort
Alarms	Number of discrete alarms	2000	4000	6000
	Number of analog alarms	50	200	
	Alarm length	80 characters		
	Number of tags / process values in an alarm	Max. 8		
	Number of alarm classes	32		
	Display	Alarm window, alarm view		
	Acknowledge error alarm individually	Yes		
	Edit alarm	Yes		
	Alarm indicator	Yes		
ALARM_S	Display S7 alarms	Yes		
Alarm buffer, retentive	Alarm buffer capacity	256	1024	
	Simultaneously queued alarm events	64	500	
	View alarm	Yes		
	Delete alarm buffer	Yes		
	Print alarms line by line	Yes		

Tags, values and lists

Object	Specification	HMI devices		
		KP400 Comfort KTP400 Comfort	KP700 Comfort to KP1200 Comfort TP700 Comfort to TP1200 Comfort	KP1500 Comfort, TP1500 Comfort to TP2200 Comfort
Tags	Number	1024	2048	4096
Limit value monitoring	Input/output	Yes		
Linear scaling	Input/output	Yes		
Text lists	Number	300	500 ¹	
Graphics lists	Number	100	500 ¹	

¹ The maximum total of text and graphics lists is 500.

Screens

Object	Specification	HMI devices		
		KP400 Comfort KTP400 Comfort	KP700 Comfort to KP1200 Comfort TP700 Comfort to TP1200 Comfort	KP1500 Comfort, TP1500 Comfort to TP2200 Comfort
Screens	Number	500		750
	Objects per screen	50	400	600
	Tags per screen	50	400	600
	Complex objects per screen (for example, bars)	5	20	40
	Template	Yes		

Recipes

Object	Specification	HMI devices		
		KP400 Comfort KTP400 Comfort	KP700 Comfort to KP1200 Comfort TP700 Comfort to TP1200 Comfort	KP1500 Comfort, TP1500 Comfort to TP2200 Comfort
Recipes	Number	100	300	500
	Data records per recipe	200	500	1000
	Entries per data record	200	1000	2000
	Recipe memory	32 KB	256 KB	4 MB
	Storage location ¹	<ul style="list-style-type: none"> • Memory card (MMC/SD) • USB storage medium • Network drive 		

¹ The number of recipe data records may be restricted by the capacity of the storage medium.

Logs

Note

The HMI devices are suitable for the logging of relatively small volumes of data.

Manage the data in several adjacent archives in a segmented circular log. The use of a large circular log has a negative effect on performance.

Object	Specification	HMI devices		
		KP400 Comfort KTP400 Comfort	KP700 Comfort to KP1200 Comfort TP700 Comfort to TP1200 Comfort	KP1500 Comfort, TP1500 Comfort to TP2200 Comfort
Logs	Number of logs	10	50	
	Number of partial logs in a segmented circular log	400		
	Entries per log ¹	10000	20000	50000
	Filing format	CSV with ANSI character set, RDB, TXT		
	Storage location	<ul style="list-style-type: none"> • Memory card • USB storage medium • Network drive 		

¹ The number of entries in the log may be restricted by the capacity of the storage medium.

Note

Data consistency

When the HMI device is switched off, consistency of the stored data is ensured only for the SIMATIC HMI Memory Card ≥ 2 GB.

With commercially available memory cards, switching off the device may result in the loss of saved data, for example due to a power failure.

The consistency of data stored in archives is only guaranteed if you use RDB format.

Safety

Object	Specification	HMI devices		
		KP400 Comfort KTP400 Comfort	KP700 Comfort to KP1200 Comfort TP700 Comfort to TP1200 Comfort	KP1500 Comfort, TP1500 Comfort to TP2200 Comfort
User view	Number of user groups	50		
	Number of users	50		
	Number of authorizations/ user permissions	32		

Infotexts

Object	Specification	HMI devices		
		KP400 Comfort KTP400 Comfort	KP700 Comfort to KP1200 Comfort TP700 Comfort to TP1200 Comfort	KP1500 Comfort, TP1500 Comfort to TP2200 Comfort
Infotexts	Length (no. of characters)	320 (depending on font)		
	For alarms	Yes		
	For screens	Yes		
	For screen objects (e.g. I/O field, switch, button, invisible button)	Yes		

Additional functions

Object	Specification	HMI devices		
		KP400 Comfort KTP400 Comfort	KP700 Comfort to KP1200 Comfort TP700 Comfort to TP1200 Comfort	KP1500 Comfort, TP1500 Comfort to TP2200 Comfort
Screen settings	Touch screen calibration ¹	Yes		
	Brightness setting	Yes		
Language change	Number of languages per project	32		
VBScript	User-specific extension of the functionality	Yes		
	Number of scripts	100	200	
Graphic objects	Vector and pixel graphics	Yes		
Trends	Number	50	300	400
Task planner	Number of tasks	10	48	
Text objects	Number	2500	40000	
Direct keys	PROFIBUS DP direct keys	Yes		
	PROFINET IO direct keys	Yes		

¹ For HMI devices with touch screen only

A

Technical Support

A.1 Service and support

You can find additional information and support for the products described on the Internet at the following addresses:

- Technical support
(http://www.siemens.de/automation/csi_en_WW)
- Support request form
(<http://www.siemens.com/automation/support-request>)
- After-sales information system for SIMATIC PC / PG
(<http://www.siemens.com/asis>)
- SIMATIC Documentation Collection
(<http://www.siemens.com/simatic-tech-doku-portal>)
- Your local representative
(<http://www.automation.siemens.com/mcms/aspa-db/en/Pages/default.aspx>)
- Training center
(<http://sitrain.automation.siemens.com/sitrainworld/?AppLang=en>)
- Industry Mall
(<http://mall.automation.siemens.com>)

When contacting your local representative or Technical Support, please have the following information at hand:

- Order number of the device (MLFB)
- BIOS version (industry PC) or image version (HMI device)
- Installed additional hardware
- Installed additional software

Tools & downloads

Please check regularly if updates and hotfixes are available for download to your device. The downloads are available on the Internet under "After Sales Information System SIMATIC PC/PG" (see above).

A.2 Troubleshooting

This section contains information on localizing and rectifying possible faults.

Error message	Possible cause	Remedy
"System card is missing or defective"	No system memory card inserted.	Insert a system memory card. Use only the SIMATIC HMI Memory Card \geq 2 GB.
	System memory card is defective.	<p>Replace the defective system memory card with a new SIMATIC HMI Memory Card.</p> <p>To continue working without the service concept, acknowledge the error message each time the HMI device is started. You can use the "Do not show this message again" option to suppress the error message.</p> <p>To reactivate the service concept, you have to insert an intact system memory card.</p>
"System card error"	The system memory card from a device of a different type has been inserted.	Replace the system memory card with the system memory card of a device of the same type.
		You can use the system memory card with the device without using the data of the system memory card. In this case, all the data in the "\System Card\SIMATIC.HMI\Active" folder will be deleted. To back up this data, activate the "Start backup" check box and specify the storage medium. Then click on the "Continue" button.

A.3 System events

System events on the HMI device provide information about internal states of the HMI device and PLC.

Note

System events are only indicated if an alarm window was configured. System events are output in the language currently set on your HMI device.

System event parameters

System events may contain encrypted parameters which are relevant to troubleshooting because they provide a reference to the source code of the runtime software. These parameters are output after the text "Error code:"

Description of the system events

A listing of all system alarms for your HMI device is provided in the Online Help of your configuration software.

Abbreviations

ANSI	American National Standards Institution
CPU	Central Processing Unit
CSV	Comma Separated Values
CTS	Clear To Send
DC	Direct Current
DCD	Data Carrier Detect
DHCP	Dynamic Host Configuration Protocol
DIL	Dual-in-Line (electronic chip housing design)
DNS	Domain Name System
DP	Distributed I/O
DSN	Data Source Name
DSR	Data Set Ready
DTR	Data Terminal Ready
IO	Input and Output
ESD	Components and modules endangered by electrostatic discharge
EMC	Electromagnetic Compatibility
EN	European standard
ES	Engineering System
ESD	Components and modules endangered by electrostatic discharge
GND	Ground
HF	High Frequency
HMI	Human Machine Interface
IEC	International Electronic Commission
IF	Interface
IP	Internet Protocol
LED	Light Emitting Diode
MAC	Media Access Control
MOS	Metal Oxide Semiconductor
MPI	Multipoint Interface (SIMATIC S7)
MS	Microsoft
MTBF	Mean Time Between Failures
n. c.	Not connected
OP	Operator Panel
PC	Personal Computer
PG	Programming device
PPI	Point-to-Point Interface (SIMATIC S7)

RAM	Random Access Memory
PELV	Protective Extra Low Voltage
RJ45	Registered Jack Type 45
RTS	Request to send
RxD	Receive Data
SD Memory Card	Abbreviation of Secure Digital Memory Card
SELV	Safety Extra Low Voltage
SP	Service Pack
PLC	Programmable Logic Controller
Sub-D	Subminiature D (plug)
TAB	Tabulator
TCP/IP	Transmission Control Protocol/Internet Protocol
TFT	Thin Film Transistor
TxD	Transmit Data
UL	Underwriter's Laboratory
USB	Universal Serial Bus
UPS	Uninterruptible power supply
WINS	Windows Internet Naming Service

Glossary

"Transfer" mode

The "Transfer" operating mode is an operating mode of the HMI device in which an executable project is transferred from the configuring PC to an HMI device.

Acknowledge

Acknowledgment of an alarm confirms that it has been noted.

Alarm logging

Output of user-specific alarms to a printer, in parallel to their output to the HMI device screen.

Alarm, acknowledgment

Acknowledgment of an alarm confirms that it has been noted.

Alarm, activated

Moment at which an alarm is triggered by the PLC or HMI device.

Alarm, deactivated

Moment at which the initiation of an alarm is reset by the PLC.

Alarm, user-specific

A user-specific alarm report specific operating states of a plant interconnected to the HMI device via the PLC.

Automation system

An automation system is a PLC of the SIMATIC S7 series, for example SIMATIC S7-300

Boot loader

The boot loader is used to start the operating system and is started automatically after power on of the HMI device. The loader is displayed after the operating system has loaded.

Configuration software

Configuration software is used to create projects used for the purpose of process visualization. WinCC represents such configuration software, for example.

Configuring PC

A configuring PC is a programming device or PC on which plant projects are created using an engineering software.

Degree of protection

The degree of protection specifies a standard of electronic equipment for a variety of ambient conditions – and the protection of humans against potential danger when using this equipment.

The degree of protection classified by IP differs from the protection class. But both involve protection against touching dangerous electric voltage. The degree of protection also classifies the protection of equipment against dirt and moisture.

Display duration

Defines whether a system event is displayed on the HMI device and the duration of the display.

EMC

Electromagnetic compatibility (EMC) refers to a usually desirable state, in which technical equipment does not disturb one another with unwanted electrical or electromagnetic effects. Electromagnetic compatibility deals with technical and regulatory questions of undesired, mutual influence in electrical engineering.

Event

Functions are triggered by defined incoming events. Events can be configured. Events which can be assigned to a button include "Press" and "Release", for example.

Field

Area reserved in configured screens for the input and output of values.

Flash memory

Flash memory is a non-volatile memory with EEPROM chips that is implemented either as mobile storage medium, or as permanently installed memory module on the motherboard.

Function key

Function keys on the HMI device can be assigned user-specific functions. The functions assigned to these keys are defined during configuration. The assignment of the function keys may be specific to an active screen or independent of it.

Half Brightness Life Time

Time period after which brightness is reduced to 50% of the original value. The specified value depends on the operating temperature.

Hardcopy

Output of the screen content to a printer.

HMI device

An HMI device is a device used for the operation and monitoring of machines and plants. The machine or plant states are visualized on the HMI device by means of graphic objects or signal lamps. The operator controls of the HMI device allow the operator to interact with the processes of the machine or plant.

HMI device image

The HMI device image is a file that can be transferred from the configuring PC to the HMI device. The HMI device image contains the operating system for the HMI device and the elements of the runtime software required to run a project.

I/O field

An I/O field enables the input or output of values on the HMI device which are transferred to the PLC.

Infotext

An infotext is a configured information on objects within a project. Infotext for an alarm, for example, may contain information on the cause of the fault and troubleshooting routines.

Object

An object is a project element such as a screen or an alarm. Objects are used to view or enter texts and values on the HMI device.

Operating element

An operating element is a component of a project used to enter values and trigger functions. A button, for example, is an operating element.

Plant

General term referring to machines, processing centers, systems, plants and processes which are operated and monitored on an HMI device.

PLC

PLC is a general term for devices and systems with which the HMI device communicates, for example SIMATIC S7.

PLC job

A PLC job triggers a function for the PLC on the HMI device.

Process visualization

Process visualization is the representation of technical processes by means of text and graphic elements. Configured plant screens allow operator intervention in active plant processes using the input and output data.

Project

A project is the result of a configuration using a configuration software. The project normally contains several screens with embedded system-specific objects, basic settings and alarms. A project configured with WinCC is saved in a project file with the extension "*.ap11".

You need to distinguish between a project on the configuring PC and an executable project on an HMI device. A project on the configuring PC can be available in more languages than can be managed on the HMI device. The project on the configuring PC can also be set up for different HMI devices. You can only transfer an executable project to an HMI device if it has been especially compiled for it.

Project file

A project file is a file from which the executable project file for use on the HMI device is generated. The project file is usually not transferred and is retained on the configuring PC.

The file name extension of a project file is "*.ap11".

Project file, compressed

Compressed format of the project file. The compressed project file can be transferred in addition to the executable project file to the corresponding HMI device. For this purpose, backtransfer must be enabled in the project on the configuring PC. The compressed project file is usually saved to an external memory card.

A compressed project file has the extension *.pdz.

Project file, executable

An executable project file is the file generated from the project file for a specific HMI device. The executable project file is transferred to the associated HMI device where it is used to operate and monitor plants.

An executable project file has the extension "*.fwc".

Protection class

The protection class is used in electrical engineering to classify and identify electrical equipment in relation to existing safety measures designed to prevent electric shock.

There are four protection classes for electrical equipment.

Recipe

A recipe is a combination of tags that form a fixed data structure. The configured data structure can be assigned data in the configuration software or on the HMI device and is then referred to as a record. The use of recipes ensures that all data assigned to a data record is transferred synchronously to the PLC.

Runtime software

The runtime software is a process visualization software used to test a project on a configuring PC.

Screen

A screen is a form of visualization for all logically related process data in a plant. The representation of the process data can be visually supported by graphic objects.

Screen object

A screen object refers to objects such as rectangles, I/O fields or alarm views which are configured for visualization or operation of the plant.

System event

A system event is assigned to the "System" alarm class. A system event refers to internal states on the HMI device and the PLC.

Tab order

The tab order defined in the course of project engineering determines the sequence for activating objects by pressing the <TAB> key.

Tag

A tag is a defined memory location to which values can be written and from which values can be read. This can be done from the PLC or the HMI device. We distinguish between external tags (process tags) and internal tags, depending on whether or not the tag is interconnected with the PLC.

Transfer

Transfer of a runtime project from the configuring PC to the HMI device.

WinCC

WinCC (TIA Portal) is engineering software for configuring SIMATIC Panels, SIMATIC Industrial PC and standard PC with the visualization software WinCC Runtime Advanced or the SCADA system, WinCC Runtime Professional.

Index

A

- ACK key, 73
- Acknowledge key, 73
- Acoustic feedback, 155
- Acoustic signal
 - For inadvertent operation, 155
 - with inadvertent operation, 80
- Acoustics
 - Feedback, 97, 98
- Add-on
 - Installing, 139, 149
 - Removing, 139, 149
- Add-ons, 23
- Address assignment
 - TCP/IP network, 119
- Addressing, 117
- Alarm
 - Functional scope, 209
- Alarm buffer
 - Functional scope, 209
- ALARM_S, 209
- Alphanumeric values
 - Entering, 161
- ALT key, 70
- Ambient conditions
 - Climatic, 198
 - Mechanical, 197
 - Test, 198
- Approval for Australia, 171
- Approvals, 169
- Assigning
 - Sound to an event, 80
- Audit, 23

B

- Backlighting
 - Reducing, 94
 - Setting, 80
- Backspace key, 70
- Backup, 79, 139, 144
 - HMI device data, 145
 - Registry Information, 79, 90
 - Temporary files, 90
 - to external storage device, 79
 - to external storage medium, 131
- Basic knowledge
 - Required, 3
- Booting, 99
- Brightness
 - Changing, 92
 - Setting, 79
- Browser
 - Home page, 79
 - Setting, 79
- Bus connection, 208

C

- Cable
 - Data exchange, 50
- Cables
 - Connecting, 41
- Cache memory
 - Internet, 127
- Calibrating
 - Touch screen, 79, 84
- Cancel key, 70
- Care, 165
- CE approval, 169
- Certificate
 - Delete, 79, 130
 - Displaying, 79
 - Importing, 79, 130
- Certificates, 169
- Changing
 - Brightness, 92
 - Color depth, 92
 - Screen orientation, 92

- Character repeat, 79
 - Screen keyboard, 82
- Clean screen, 166
- Cleaning product, 165
- Clearance
 - HMI device, 32
- Climatic
 - Storage conditions, 196
 - Transport conditions, 196
- Closing
 - Project, 163
- Color depth
 - Changing, 92
 - Setting, 79
- Compatibility conflict, 144
- Components sensitive to electrostatic charge, 174
- Computer name
 - For network operation, 118
 - Setting, 80
- Conductor cross-section, 44
 - Equipotential bonding, 42
- Configuration phase, 137
- Configuring
 - Network, 118
 - Operating system, 65
 - Remote operation via Sm@rtServer, 80
 - Screen keyboard, 79, 81
 - Sm@rtServer, 80, 125
 - Time server, 80
- Configuring PC, 137
 - Connecting, 46
 - Wiring diagram, 46
- Connecting
 - Equipotential bonding, 42
 - PLC, 48
 - Power supply, 44
 - Power supply terminal, 45
 - Printer, 50
 - PROFINET, 48
 - Uninterruptible power supply, 45
 - USB device, 49
- Connection, 208
- Connection sequence, 41
- Connections to PLC
 - Number, 208
- Control key, 61
- Control Panel, 67
 - MPI, 116
 - Opening, 67
 - Password protection, 66
 - PROFIBUS, 116

- Convention
 - Style, 4
 - Term, 5
- Converters and adapters, 21
- Cookies, 79, 128
- CTRL key, 70
- Currency, 80
- Cursor key, 61, 70

D

- Data channel
 - Enabling, 113
 - Locking, 113
 - Parameter assignment, 80, 113
- Date, 79
 - Setting, 87
 - Synchronizing, 87
- Date format, 80, 89
- Date/time properties, 79, 88
- Decimal, 159
- Default gateway, 121
- Degree of protection, 33
 - Protection against ingress of solid foreign bodies, 199
 - Protection against water, 199
- Delay time
 - Setting, 80, 105
- Delete
 - Certificate, 79, 130
- Delete key, 70
- Dewing, 196
- DHCP, 120
- Direct key, 157
 - Bit assignment, 200
 - Functional scope, 212
- Disabling
 - Service concept, 64
- Display
 - HMI devices, 191, 193
- Displaying
 - Certificate, 79
 - Displaying information about the HMI device, 101
 - HMI device information, 79
 - Infotext, 162
 - Memory information, 102, 103
 - System information, 102, 103
- Disposal, 167

- DNS, 121
 - Server,
- Documentation
 - Enclosed, 29
- Double-click, 79
 - Setting, 83
- Drop-down list box
 - Opening, 72

E

- EC Declaration of Conformity, 169
- Elbow adapter, 21
- Electrical isolation
 - Safe, 44
- Electrical potential difference, 42
- Electromagnetic compatibility, 172
- E-Mail
 - Setting, 80, 124
- EMC, 172
- Emission, 27, 173
- Enable
 - SecureMode, 86
 - Service concept, 62
- Encryption, 128
- END key, 70
- Enter key, 70
- ENTER key, 70
- Entering
 - Alphanumeric values, 161
 - Hexadecimal values in the project, 159
 - Numeric values in the project, 160
 - Value, 158
- Entry on the HMI device
 - By means of function key, 156
- Equipotential bonding
 - Cable, 43
 - Connecting, 42
 - Requirements, 42
 - Wiring diagram, 43
- ESC key, 70
- ESD, 174
- ESD guidelines, 174
- Ethernet parameters
 - Setting, 79
- Ethernet settings
 - IP address, 120
- Excel Viewer, 23

F

- Factory settings, 47
- Feedback
 - Acoustic, 97, 98, 155
 - Optical, 154
- Figure, 5
- FM Approval, 170
- Front view
 - 4" model,
 - Devices with 7" and larger displays,
- Function
 - Additional, 212
- Function key, 61
 - Labeling, 34
- Function keys
 - Global assignment, 156
 - Local assignment, 156
- Function test, 53
- Functional scope
 - Alarm buffer, 209
 - ALARM_S, 209
 - Alarms, 209
 - Graphics list, 210
 - Infotext, 212
 - Limit value monitoring, 210
 - Log, 211
 - Recipe, 210
 - Safety, 212
 - Scaling, 210
 - Screen, 210
 - Tags, 210
 - Text list, 210
 - User view, 212

G

- Graphics list
 - Functional scope, 210
- Guidelines
 - ESD guidelines, 174
- Guidelines for Explosion Protection, 171

H

- Hexadecimal values
 - Entering in the project, 159
- HMI device
 - Backing up data, 145
 - Clearance, 32
 - EMC-compatible installation, 172
 - Mounting, 39
 - Operating with system keys, 69
 - Operator control, 60
 - Resetting to factory settings, 148
 - Restart, 99
 - Restarting, 79
 - Restoring data, 145
 - Shutting down, 53
 - Switching on, 52
 - Technical specifications, 191, 193
 - Testing, 52
 - Transfer license key, 150
 - Updating the operating system (Windows CE), 147
- HMI devices
 - Display, 191, 193
 - Input device, 191, 194
 - Interfaces, 192, 194
 - Memory, 192, 194
 - Weight, 191, 193
- HMI Input Panel
 - Options, 80
- HOME key, 70
- Home page
 - Internet, 126

I

- Identification, 123
- Importing
 - Certificate, 79, 130
- Inadvertent operation
 - Acoustic signal, 80, 155
- Information
 - For the HMI device, 101
- Infotext
 - Displaying, 162
 - Functional scope, 212
 - Key, 73
- Initial startup, 137
- Input device
 - HMI devices, 191, 194
- Input Panel, 79
- Installing
 - Add-on, 139, 149

- Instructions
 - General, 27
- Insulation test
 - Test voltage, 199
- Interface
 - Rated load, 49
- Interfaces
 - HMI devices, 192, 194
- Interference
 - Pulse-shaped, 172
 - Sinusoidal, 173
- Internal clock, 87
- Internet
 - Browser, 69
 - Cache memory, 127
 - Explorer, 69
 - Home page, 126
 - Options, 79
 - Search engine, 126
 - Security settings, 79
 - Settings, 80, 124
- Internet options
 - Privacy, 128
- IP address
 - Ethernet, 120
 - Setting, 79
- IT Security, 26

K

- Key
 - ACK, 73
 - ALT, 70
 - Cancel, 70
 - CTRL, 70
 - Cursor, 70
 - Delete, 70
 - END, 70
 - ENTER, 70
 - ESC, 70
 - HOME, 70
 - Infotext, 73
 - Scroll back, 70
 - Scroll forward, 70
 - SHIFT, 70
 - Switching, 70
 - TAB, 71
 - Tabulator, 71
- Keyboard
 - Safety instruction, 61
- Keyboard properties, 79

L

- Labeling
 - Approvals, 170
 - EC Declaration of Conformity, 169
 - Function key, 34
 - Guidelines for Explosion Protection, 171
- Labeling strips
 - Attaching, 35
 - Dimensions, 189
 - Printing, 34
- LAN connection, 79
- Language change
 - Functional scope, 212
- License
 - Managing, 150
- License key
 - Transfer to an HMI device, 150
 - Transferring, 139
 - Transferring back, 139
- License keys, 150
- Limit test, 159
- Limit value monitoring
 - Functional scope, 210
- List of abbreviations, 215
- Loader, 65
 - Opening, 65
- Log
 - Format, 211
 - Functional scope, 211
- Logon data, 123

M

- Maintenance, 165, 167
- Managing
 - License, 150
- Mechanical
 - Storage conditions, 196
 - Transport conditions, 196
- Media Player, 68
- Memory
 - HMI devices, 192, 194
- Memory card, 21
 - Restoring file system, 90
- Memory card lock protection, 21
- Memory information, 80
 - Displaying, 102, 103
- Memory management, 79, 135
- Memory media, 21
- Microsoft Excel Viewer, 23
- Microsoft PDF Viewer, 23

- Microsoft Word Viewer, 23
- Mounting
 - EMC-compatible, 172
 - HMI device, 39
 - Horizontal mounting, 31
 - Vertical, 31
- Mounting clamp
 - Mounting, 37
- Mounting cutout
 - Compatibility to other HMI devices, 33
 - Dimensions, 34
 - Preparing, 34
- Mounting location, 29
- Mounting position, 31
- Mouse properties, 79
- MPI
 - Setting, 80, 116
- Multi-key operation, 154

N

- Name server, 121
- Network
 - Configuring, 118
 - Logon data, 79
 - Set up, 117
 - Setting, 119
- Network & dial-up connections, 79
- Network ID, 79
- Network operation
 - Computer name, 118
- Non-isolated plant configuration, 44
- Notice of protected rights, 4
- Number format, 80, 89
- Numeric value
 - Decimal places, 159
 - Limit test, 159
- Numeric values
 - Entering in the project, 160

O

- Offline
 - Operating mode, 138
 - Test, 143
- Online
 - Operating mode, 138
 - Test, 144

- OP properties, 79
 - Device, 101
 - Memory monitoring, 135
 - Persistent storage, 90
 - Touch, 84
- Opening
 - Control Panel, 67
 - Drop-down list box, 72
 - Loader, 65
- Operating
 - Control Panel with system keys, 72
 - Dialog with system keys, 72
 - Explorer with system keys, 71
 - Feedback, 154
 - HMI device with system keys, 69
 - Project with system keys, 73
 - Windows CE with system keys, 71
 - With external keyboard, 153
 - With external mouse, 153
- Operating instructions
 - Purpose, 3
 - Scope, 3
- Operating mode, 138
 - Changing, 138
 - Offline, 138
 - Online, 138
 - Transfer, 52, 138
- Operating system
 - Configuring, 65
- Operation feedback, 154
 - Setting, 80
- Optical feedback, 154

- P**
- Parameter assignment
 - Data channel, 80, 113
- Password
 - Specifying, 86
- Password properties, 79, 86
- Password protection, 79
 - Removing, 87
 - Set up, 86
 - Taskbar, 66
- PDF Viewer, 23
- PELV, 44
- Plant configuration
 - Non-isolated, 44

- PLC
 - Connecting, 48
 - Number of connectable, 208
 - Protocol, 208
 - Wiring diagram, 48
- Power failure, 144
- Power supply
 - Connecting, 44
 - HMI devices, 192, 195
 - Setting, 80
 - State, 80
 - Wiring diagram, 44
- Power supply terminal
 - Connecting, 45
- Printer
 - Connecting, 50
 - Setting properties, 79
 - Wiring diagram, 50
- Printer connection
 - Setting, 96
- Printer properties, 79, 96
- Printing
 - Labeling strips, 34
 - Via network printer, 118
- Process control phase, 137
- PROFIBUS DP
 - Setting, 80, 116
- PROFINET, 117
 - Addressing, 117
 - Connecting, 48
- PROFINET IO
 - Communication, 48
 - Communication fault, 208
 - Setting, 80
- PROFINET services
 - Disabling direct keys, 109
 - Enable PROFIenergy, 109
 - Enabling direct keys, 109
- Project
 - Closing, 163
 - Offline testing, 143
 - Reuse, 138
 - Testing online, 144
 - Transferring, 137, 139
- Protected trademark, 4
- Protection class, 199
- Protective foil, 21
- Protective measure
 - Static electricity, 176

Protocol
 PLC, 208
 Proxy
 Server, 79, 124, 127
 Setting, 79

R

Radiation, 26
 High frequency radiation, 26
 Radio interference, 27
 Emission, 173
 Rated load
 Interface, 49
 Real-time clock
 Internal, 87
 Rear view
 4" model,
 Devices with 7" and larger displays,
 Recipe
 Functional scope, 210
 Recommissioning, 137
 Recycling, 167
 Reducing
 Backlighting, 94
 Regional and language settings, 80, 89
 Regional settings, 89
 Registered trademark, 4
 Registry Information
 Backup, 79, 90
 Remote control
 Configuring via Sm@rtServer, 80
 Removing
 Add-on, 139, 149
 Password protection, 87
 SecureMode, 87
 Repairs, 167
 Replacing HMI device
 With service concept, 63
 Reset to factory setting, 139
 Reset to factory settings, 146
 Resetting
 HMI device factory settings, 148
 Resetting to factory settings, 47
 Restore, 79, 131, 139, 144
 From external storage medium, 133
 HMI device data, 145
 Restoring
 From external storage medium, 79
 From memory card, 90

Restoring data
 HMI device, 145
 Returns Center, 167
 Reverse polarity protection, 45
 RS 422 to RS 232 converter, 21

S

S7 transfer settings, 80
 Safe electrical separation, 44
 Safety
 Certificates, 169
 Functional scope, 212
 Standards, 169
 Safety instruction
 Backlighting, 94
 Compatibility conflict, 144
 Damage to the HMI device, 41
 Device name, 110
 Direct key, 156
 Equipotential bonding cable, 43
 Functional problem, 49
 Keyboard, 61
 Loss of data possible, 133
 Memory distribution, 103
 Multi-key operation, 154
 Operation indoors, 27
 Path, 104, 105
 Power failure, 144
 Preventing inadvertent operation, 165, 166
 Project file, 104, 105
 Restart, 99
 Storage, 196
 Switching infotext, 163
 Time-dependent reactions, 87
 Touch screen, 60
 Transfer mode, 115
 Transport, 196
 Unintentional action, 60, 61
 Unintentional response, 165, 166
 Unintentional transfer mode, 113
 USB port, 49
 Scaling
 Functional scope, 210
 Screen
 Functional scope, 210
 Screen keyboard, 79
 Character repeat, 82
 Configuring, 81
 Usage, 78

- Screen orientation
 - Changing, 92
 - Setting, 79
- Screen saver, 80, 94
 - Setting, 94
- Scroll back key, 70
- Scroll forward key, 70
- Search engine
 - Internet, 126
- SecureMode
 - Enable, 86
 - Removing, 87
 - Switching on again, 87
- Security information, 26
- Security settings, 79
- Service concept
 - Disabling, 64
 - Enable, 62
 - Replacing HMI device, 63
- Service pack, 167
- Service packages, 21
- Set up
 - Network, 117
 - Password protection, 86
 - Time server, 111

- Setting
 - Backlighting, 80
 - Brightness, 79
 - Browser, 79
 - Color depth, 79
 - Computer name, 80
 - Date, 87
 - Date format, 89
 - Date/Time, 79
 - Delay time, 80, 105
 - Double-click, 83
 - E-Mail, 80
 - E-mail connection, 124
 - Ethernet parameters, 79
 - IP address, 79
 - Language, 157
 - MPI, 80, 116
 - Name server, 79
 - Network, 119
 - Number format, 89
 - Operation feedback, 80
 - Power supply, 80
 - Printer connection, 96
 - Printer properties, 79
 - PROFIBUS, 116
 - PROFIBUS DP, 80
 - PROFINET IO, 80
 - Proxy, 79
 - Regional data, 89
 - Screen orientation, 79
 - Screen saver, 94
 - Sound, 98
 - Storage location, 80, 104
 - Time, 87
 - Time format, 89
 - Transfer mode, 141
- Setting language, 157

- Settings
 - Internet, 80
 - Language, 80
 - Regional, 80
 - S7-Transfer, 80
 - Shift key, 70
 - SHIFT key, 70
 - Shutting down
 - HMI device, 53
 - Side view
 - 4" model,
 - Devices with 7" and larger displays,
 - Siemens HMI input panel options, 79
 - Sm@rtServer, 23
 - Configuring, 80, 125
 - SMTP server, 124
 - Software add-ons, 23
 - Sound
 - Assigning to an event, 80
 - Setting, 80, 98
 - Setting event, 98
 - Spare part
 - Plastic clamp, 21
 - Power supply terminal, 21
 - Standards, 169
 - Start
 - HMI device, 79, 99
 - Transfer, 142
 - Static electricity
 - Protective measures, 176
 - Storage conditions, 196
 - Storage location
 - Setting, 80, 104
 - Storage medium
 - Restoring from external, 133
 - Saving to external, 131
 - Strain relief, 53
 - Subnet mask, 121
 - Switching on
 - HMI device, 52
 - Switching on again
 - SecureMode, 87
 - Synchronizing
 - Date and time, 87
 - System events
 - in the online help, 214
 - Parameters, 214
 - System information, 80
 - Displaying, 102, 103
 - System key, 61
 - System keys
 - Operating a dialog, 72
 - Operating a project, 73
 - Operating the Control Panel, 72
 - Operating the Explorer, 71
 - Operating Windows CE, 71
 - System properties, 80
 - Device name, 118
 - General, 102
 - Memory, 103
- T**
- TAB key, 71
 - Tabulator key, 71
 - Tags
 - Functional scope, 210
 - Task planner
 - Functional scope, 212
 - Taskbar, 65
 - TCP/IP address, 119
 - Technical specifications
 - Display, 191, 193
 - HMI devices, 191, 193
 - Input device, 191, 194
 - Interfaces, 192, 194
 - Memory, 192, 194
 - Power supply, 192, 195
 - Temporary files
 - Backup, 90
 - Test
 - For ambient conditions, 198
 - Testing
 - HMI device, 52
 - Text list
 - Functional scope, 210
 - Time, 79
 - Setting, 87
 - Synchronizing, 87
 - Time format, 80, 89
 - Time server
 - Configuring, 80
 - Set up, 111
 - Time zone
 - Setting, 87
 - Time-dependent reactions, 87
 - Touch screen
 - Calibrating, 79, 84
 - Safety instruction, 60
 - Trademark, 4

Transfer, 137, 138, 140
 Cancel, 52
 Start, 142
 Starting automatically, 140
 Starting manually, 140
Transfer mode
 Setting, 141
 Unintentional, 113
 Via MPI, 115
 Via PROFIBUS DP, 115
Transfer settings, 80, 113
 Channel, 113
 Directories, 104, 105
Transferring
 License key, 139
 License key on HMI device, 150
 Project, 137, 139
Transferring back
 License key, 139
Transport conditions, 196
Transport damage, 29
Trends
 Functional scope, 212

U

UL approval, 170
Unintentional action, 60, 61, 154
Unintentional transfer mode, 113
Uninterruptible power supply, 45
Updating
 Operating system of the HMI device (Windows CE), 147
Updating the operating system, 139, 146
UPS properties
 Configuration, 106
 Current status, 108
Usage
 Screen keyboard, 78
USB device
 Connecting, 49
USB flash drive, 21
Use
 Conditions, 197
 In residential areas, 27
 Industrial, 27
 With additional measures, 197
User name, 123
User view
 Functional scope, 212

V

Value
 Entering, 158
VBScript
 Functional scope, 212
Viewer, 68
Volume, 97
 Setting, 80
Volume & Sounds Properties, 80

W

Weight
 HMI devices, 191, 193
WinCC flexible internet settings
 E-mail, 124
 E-Mail, 80
Windows CE Desktop
 Password protection, 66
Windows CE taskbar, 65
WINS, 121
 Server, 117
Wiring diagram
 Configuring PC, 46
 Equipotential bonding, 43
 PLC, 48
 Power supply, 44
 Printer, 50
Word Viewer, 23